



# DETAIL MANUAL

# for Vertical Seam



**Best Buy Metals**

**Toll Free 1-800-728-4010 / Phone 423-479-6382 / Fax 423-728-3066**

[www.BestBuyMetals.com](http://www.BestBuyMetals.com)

**Vertical Seam  
Roofing Panels**

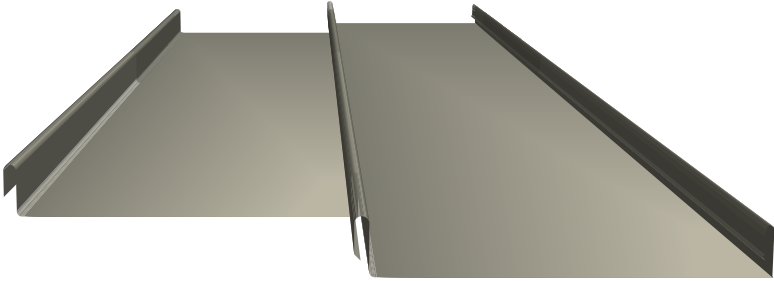
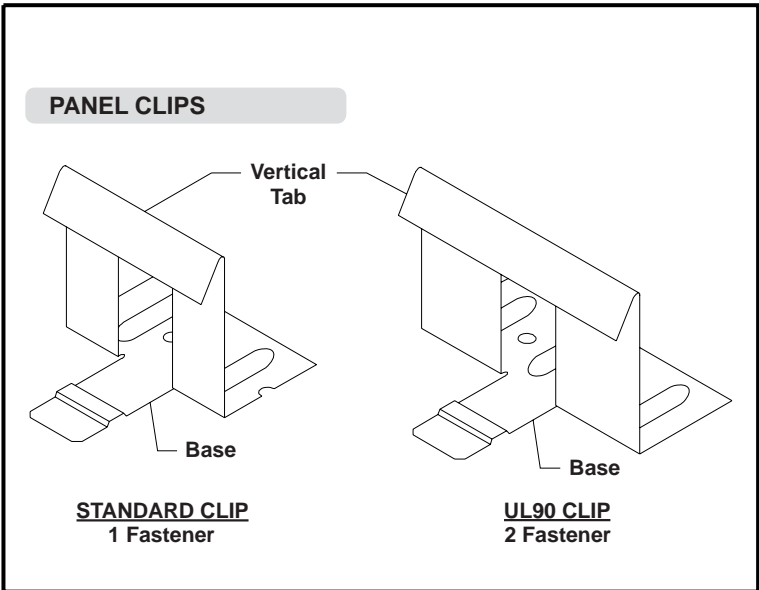
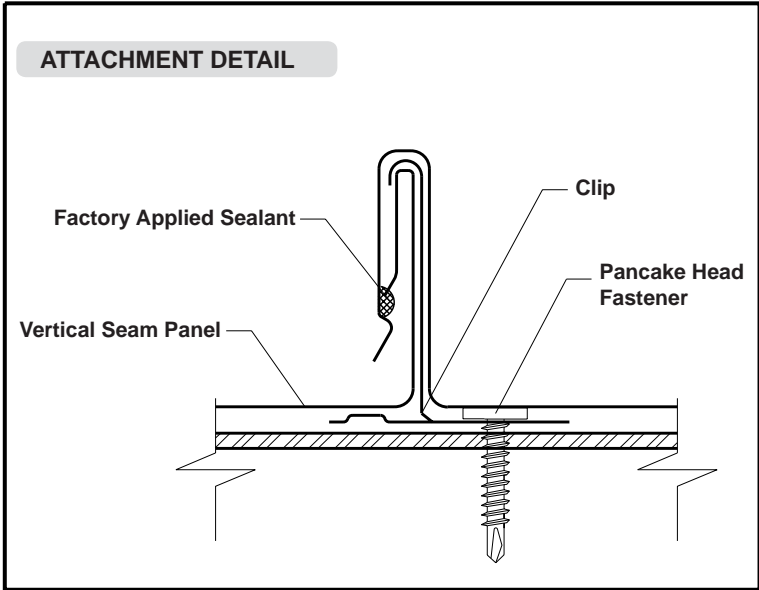

Fig. 2 Vertical Seam  
Has 1-3/4" high ribs

Vertical Seam uses a locking rib feature, which offers a 1<sup>3</sup>/<sub>4</sub>-inch rib that attaches with specially designed clips. It comes in widths of 12, 16, and 18 inches.



Vertical Seam roofing is available in either 25-year acrylic-coated Galvalume® or several different colors, comprising of 45 year low gloss paint systems on the finish side, with primer and washcoat on the reverse side.

We carry both stock and custom trims and flashings, and provide screws and other accessories. Delivery or customer pick-up of panels is also available.



While there are many possible trim and attachment solutions in the application of standing seam roofing, our sales team endorses the methods shown in this manual as being among the best recommended in the standing seam industry. We are glad to offer our advice, suggestions, or comments to those who prefer variations of these procedures. We cannot endorse methods that are unfamiliar to the industry, however, and can only support those which meet the standards of engineering that have been passed in controlled tests, or have been shown reliable by experienced contractors.

# Standing Seam Trim

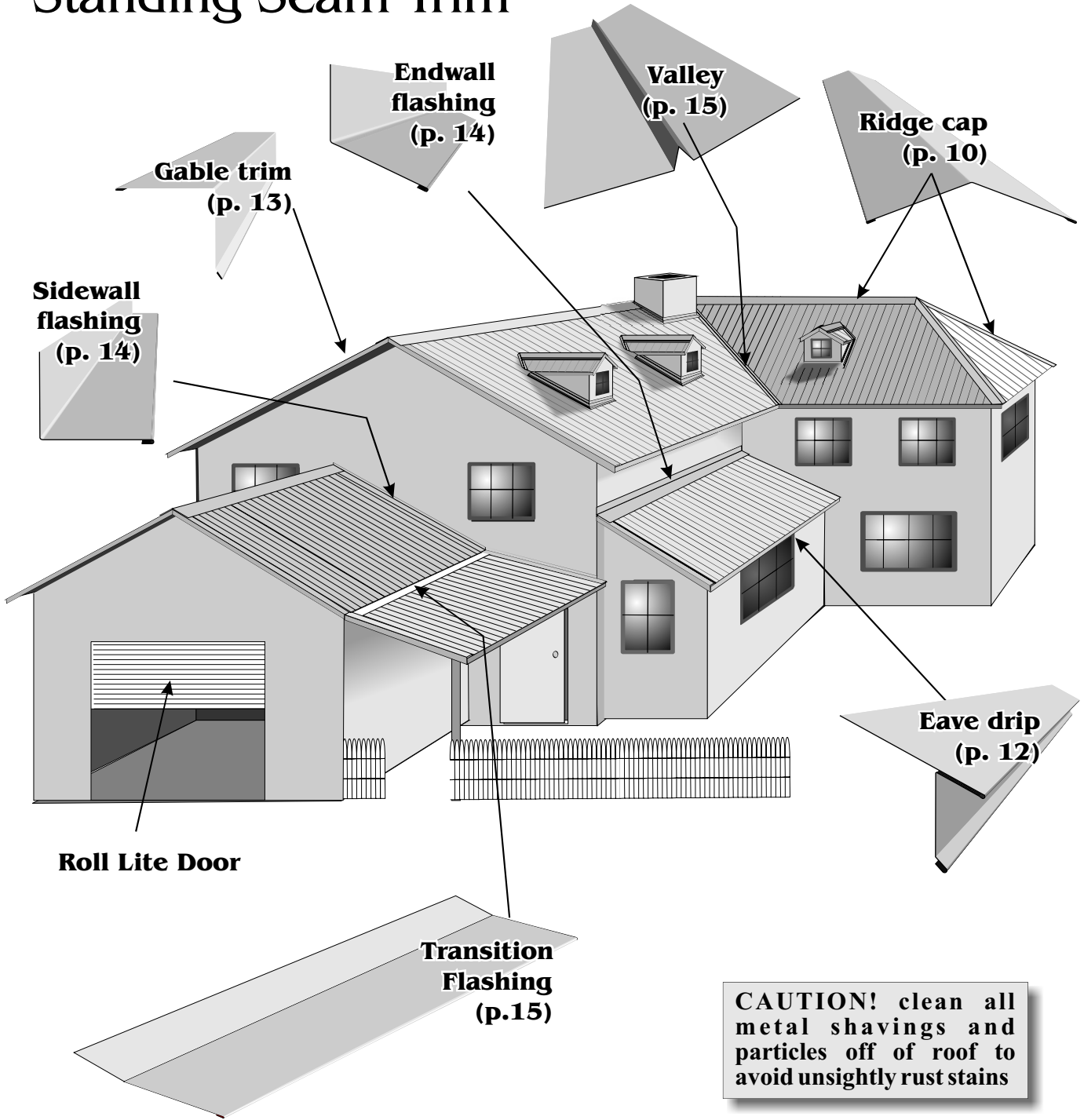

Fig. 5 Roofing trims and flashings are named by the location or function of that particular piece on the building.

## Installation of Panels

### Roof Pitch

We require at least a 3/12 pitch for Vertical Seam, to ensure proper water drainage. This means that the minimum roof slope required for panels is 3 inches of rise per foot. Consult our representative for recommendations for your particular roof pitch, and about roofing options if you have less than this minimum.

### Ordering and Applying Trim

The most common flashing for standing seam roofing is the *ridge cap*, which is used at the peak of a roof where two opposing roof slopes join, and attaches to the roof with *z-flashing*. Other flashings that attach with z-flashing include *transition flashing* (which also requires panel starter), *end wall* and *sidewall flashings*. *Panel starter* is required to attach panels over *valleys*, Eave flashings include *gable flashing*, which runs up the sloped ends of the roof, and *drip edge*, which trims out the lower ends of the panels and provides a surface for the attachment of the lower end of the panel. Both gable flashing and drip edge are often applied above *fascia* trim, and may be attached with either surface screws or hidden *eave cleats*. For details about the application of each type of trim, see the details provided on pgs. 10-15.

**Roof pitch must be given when ordering ridge caps, endwalls, valleys, and eave drip. When a steeper roof slope meets a lesser slope, both slopes should be mentioned when ordering transition flashing.**

### *Dormer detail*

Fig. 6 Most of the basic standing seam trims are used on dormers. The bottom corners of the dormer are similar to the placement of sidewall and endwall flashings on chimneys. All but valleys and eave drip require z-flashing; valleys require panel starter, and eave drip may be screwed or fastened with eave cleats.

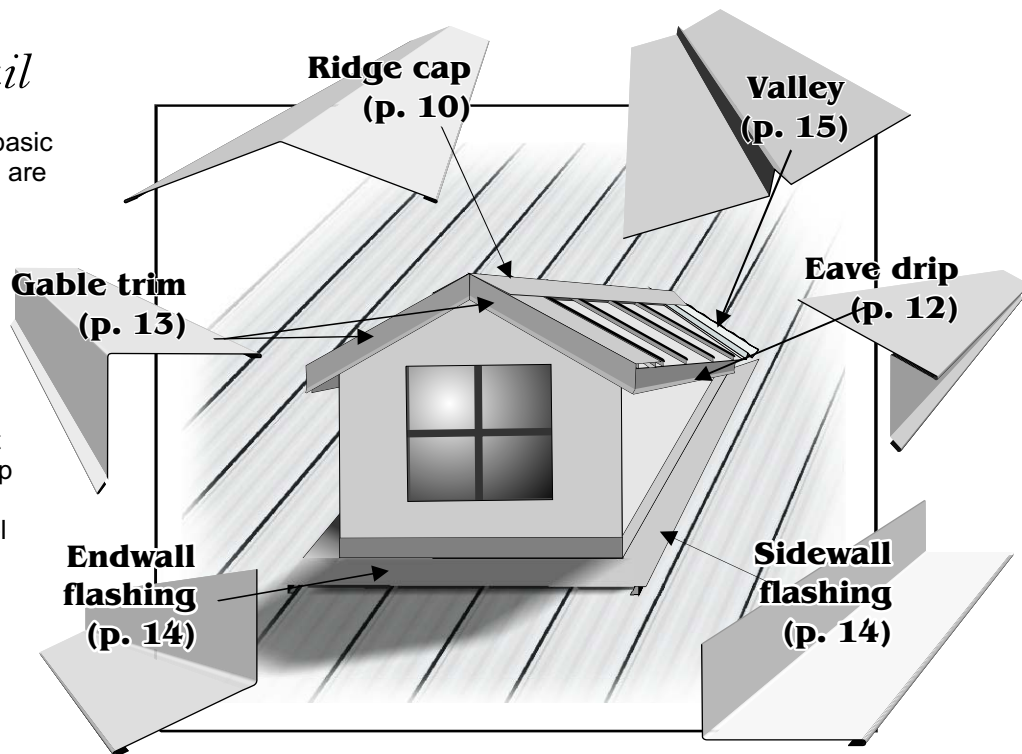

## General Principles of a Typical Installation—Hidden Fastener System

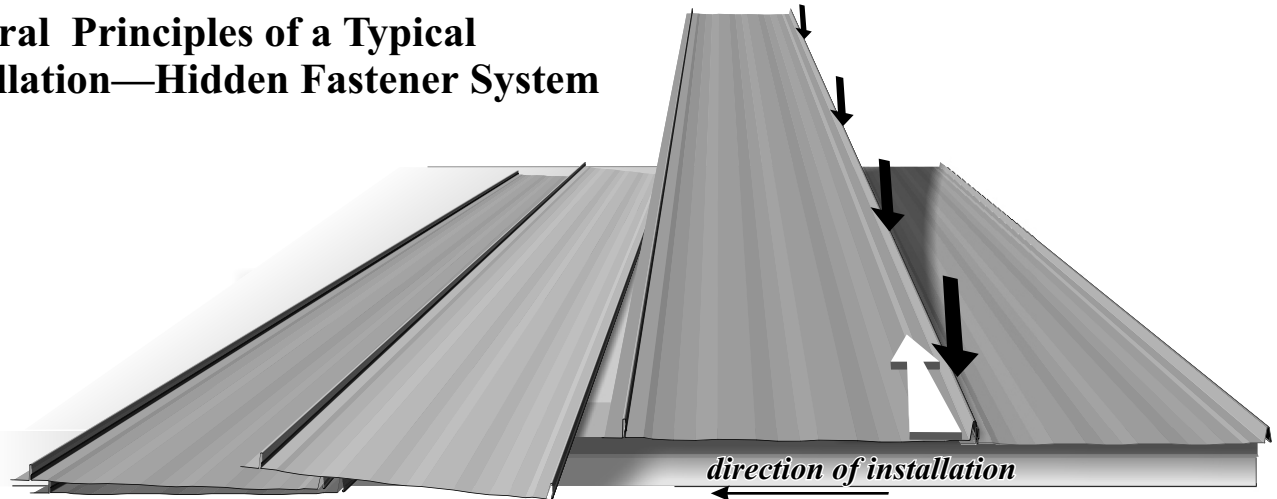

Fig. 7 Each panel should be installed over the extended eave drip, pressed down and attached with the appropriate fasteners, and eave hems finished before installing the next panel.

standing seam panel.

When used, extended drip edge should be installed first along the drip edge of the roof. The lower end of each panel is then trimmed and the hem pre-bent before installation (see p. 12). The starter panel is laid out with the overlap side against an eave or wall and the hem pulled up tight and then compressed around the eave drip. The clips are screwed off completely with pancake screws before the next panel is installed. Care should be taken that the starter panel is square with the roof, since the first panel determines the lay of all that follow it.

The pre-bent eave end of the next panel is then pulled tight against the drip edge and pressed or “walked” down over the first panel, its nailstrip secured, and the next panel applied, and so on. Each panel is always screwed off and the hem finished before installing the next. The unfastened length against the gable or wall is secured (then or later) with z-flashing and either gable rakes (on the gable eave) or sidewalls (against a wall).

## Ordering Roof Panels and Screws

Care should be taken to order panels of the correct length to avoid having to make corrective measures after purchase. Panel lengths should fall 2 to 3 inches short of the ridge *when a vented ridge is desired*, and should be ordered to extend 2½ inches past the eave when being attached to extended drip edge (see p. 9 or, if being used with gutters, p. 6). Our sales personnel are ready to assist customers with information specific to their particular roof.

Special, flat-headed screws called *pancake screws* are used to attach the clips that secure the locking panels. Woodgrip® pancakes are used when going into wood decking, or self-drilling pancakes for going into metal purlins. The same screws also secure attachment flashings like z-flashing, panel starter, and eave cleats. 1/8-inch stainless rivets are recommended for attaching ridge caps, endwall and sidewall flashings, transition flashings, and any other flashings that attach to z-flashing. See page 8 for more information on screw spacing and ordering.

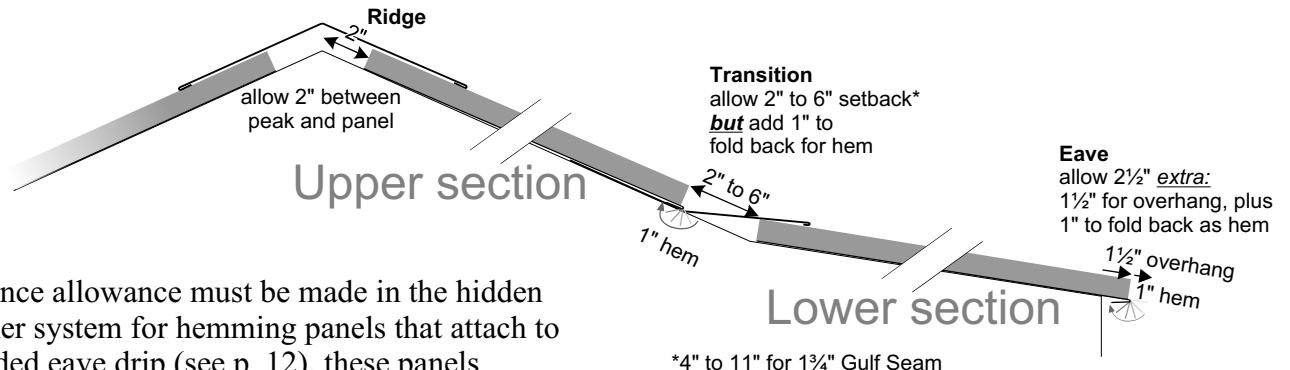

Since allowance must be made in the hidden fastener system for hemming panels that attach to extended eave drip (see p. 12), these panels should be ordered approximately 2½" longer than the substrate decking to allow panel length for the 1½" nose on extended drip edge plus the 1" hem. Likewise, panels ending in valleys should be ordered 1" longer for hemming, but with allowance made for a 3 or 4" passageway between the panel and the valley diverter to allow for the flow of water (subtract 3 or 4").

Fig. 8 Allowances must be made when ordering panels to allow for hemming of panels, overhang, ridge venting, and errors.

Where the deck makes a transition from a higher to lesser pitch, lower panels should be ordered from the transition point downward allowing for drip edge (as above), and upper panels must allow for a setback away from the transition point depending upon the roof pitch, the less the difference in pitch, the greater the setback, and the more the need for a longer length on the lower side of the transition flashing (see p. 15 for details).

The general principles of attaching the upper and lower edges of standing seam roofing are most thoroughly covered in the sections on "Drip edge"(p. 12) and "Ridge caps" (p. 10).

### Trimming and Cutting Steel Panels

The best devices for cutting steel panels *across the profile* are nibblers, and various shear attachments for drills. Hand operated snips also work. Nibblers, and especially

Filings left on the roof caused by the application of screws can leave rust marks on panels and trim. Care should be taken to brush all such particles from roof surfaces immediately after application.

To cut panels lengthwise: Note carefully where the panel is to be cut, and, using a straightedge, score deeply down the length of the panel with a sharp-pointed utility knife. Folding the panel along the score mark, and bending back again if necessary, should produce a clean break in the panel.

### Keep Materials Dry!

Paint and finishes of our panels and trim are designed to withstand severe rain and wet weather conditions. Neither paint, galvanized, or Galvalume finishes, however, are designed to be in continuous contact with water for long periods of time. **Damage will result if uninstalled panels or trim are allowed to remain wet in storage.** Be sure to store material that will not be installed immediately in a dry location. Wet material should be air-dried and re-stacked if installation is not planned right away.

## How to Figure and Apply Screws Cleats, and Other Accessories

Standing seam roofing is particularly noted for its use of hidden fasteners. *Pancake screws* are used because they are strong and yet have a low profile that does not interfere with panel and trim installation.

For Vertical Seam, one clip is applied every 2-4 feet, with either one (for standard clips) or two (for UL 90 clips) screws to hold each clip.

Vertical Seam	z-flashing	eave cleats	panel starter	rivets	pancake screws	hemming tool	butyl tape	caulk (tubes)
Ridge cap	2			16	30			2
Extended Drip edge		1			8	yes		
Gable trim	1	1		8	12		10'	
Sidewall	1			8	12		10'	
Endwall	1			8	15		10'	1
Transition flashing	1		1	8	23	yes	10'	1
Valley			2		12	yes	20'	

Fig. 9 Above chart is for a typical S-Seam roof with all hidden fasteners. For each type of trim on the left, the amount of the necessary accessory at the top of the chart is shown in each box. While caulk will work where butyl sealant is shown, we recommend butyl sealant on full lengths of trim because it is economical and easy to apply.

## Policies

**Delivery policy** Delivery charges apply to all orders where delivery is requested, as well as crating charges in most cases. Please consult your sales department for details.

**Sales tax** All orders picked up at Best Buy Metals, and all orders delivered within the state of Tennessee, are subject to state sales tax. Tax exemptions should be verified prior to delivery or customer pickup. Most orders delivered out-of-state are tax exempt.

**Warrantied products** Painted Vertical Seam panels come with a 45-year coil manufacturer's warranty, and unpainted Galvalume comes with a 25-year warranty. All trim is manufactured from the best grade in stock of the particular color ordered.

**Indemnity** All prices and designs are subject to change without notice

**Disclaimer** While we have made every attempt at accuracy in this manual, we are not responsible for typographic, printing, or technical errors.

**Summary of Stock Trims and Flashings**  
*special order information*

<i>item</i>	<i>special order information</i>
<b>Ridge caps</b>	State roof pitch when ordering. Also available in larger widths. Attached with Z-flashing (2 per ridge cap) and rivets.
<b>Extended Drip Edge</b>	Specify roof pitch when ordering. Special tools required to attach panels.
<b>Gable flashing</b>	Use butyl sealant between step rake and panel.
<b>Valleys</b>	Specify pitch when ordering. Offset cleats necessary for hidden screw application. Butyl sealant used under starter.
<b>Sidewall</b>	Require Z-flashing and rivets. Use butyl sealant between sidewall flashings and panel.
<b>Endwall</b>	Specify pitch when ordering. Attaches with Z-flashing and rivets.
<b>Transition flashing</b>	Specify pitches of both roof sections. Attaches with Z-flashing and rivets (lower) and offset cleat with pancake screws (upper).

# Ridge Cap

The Ridge Cap is used to seal the upper point at which two slopes meet. This can be both along the ridge of the roof as well as the covering for a hip, as well as on the ridge of dormers.

Attachment to the roof is most generally accomplished through the use of z-flashing. Z-flashings are either notched or cut to length (to fit between panel ribs) and attached with screws to the roof through the panels. Ridge caps are in turn attached with rivets to the z-flashing. Whether the z-flashing is notched or cut to length, gaps between it and the panels should be kept to a minimum (no more than 1/4 inch) since the gap will be sealed with caulk.

Z-flashing must be sealed both beneath and where it butts against the panel ribs with Solar Seal 900® caulk or equivalent. Thus sealed, z-flashing forms a water-proof barrier to protect the roof peak from leaks from blowing rain. When used on a hip roof, z-flashing is cut or notched at whatever widths are appropriate for the pitch and cut of the hip.

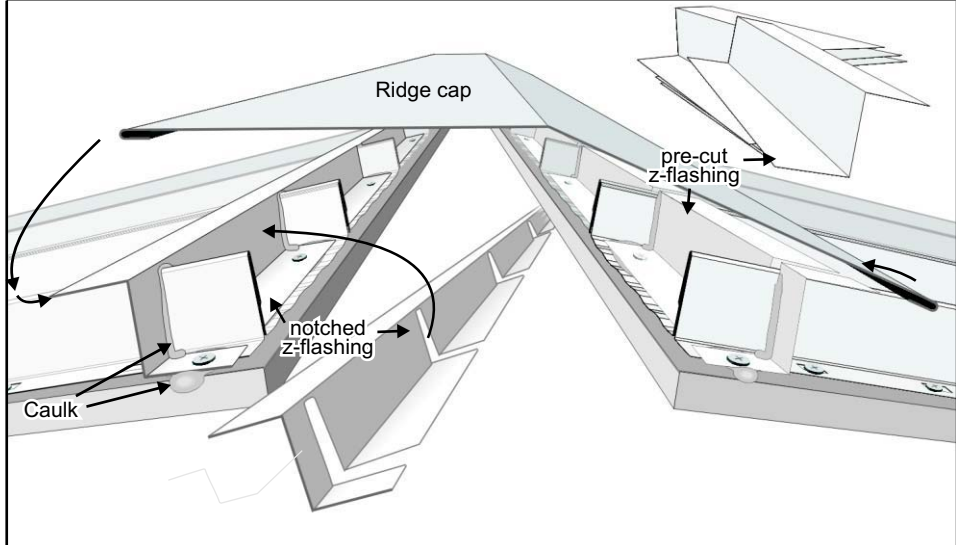

Fig. 10 To attach ridge caps, z-flashings are either notched (left) or cut into pieces (right) and mounted with screws at the upper ends of the panels. Caulk is applied on the bottom side and around the panel ribs to seal the ridge against rain. The mounted ridge cap is attached to the z-flashing with rivets.

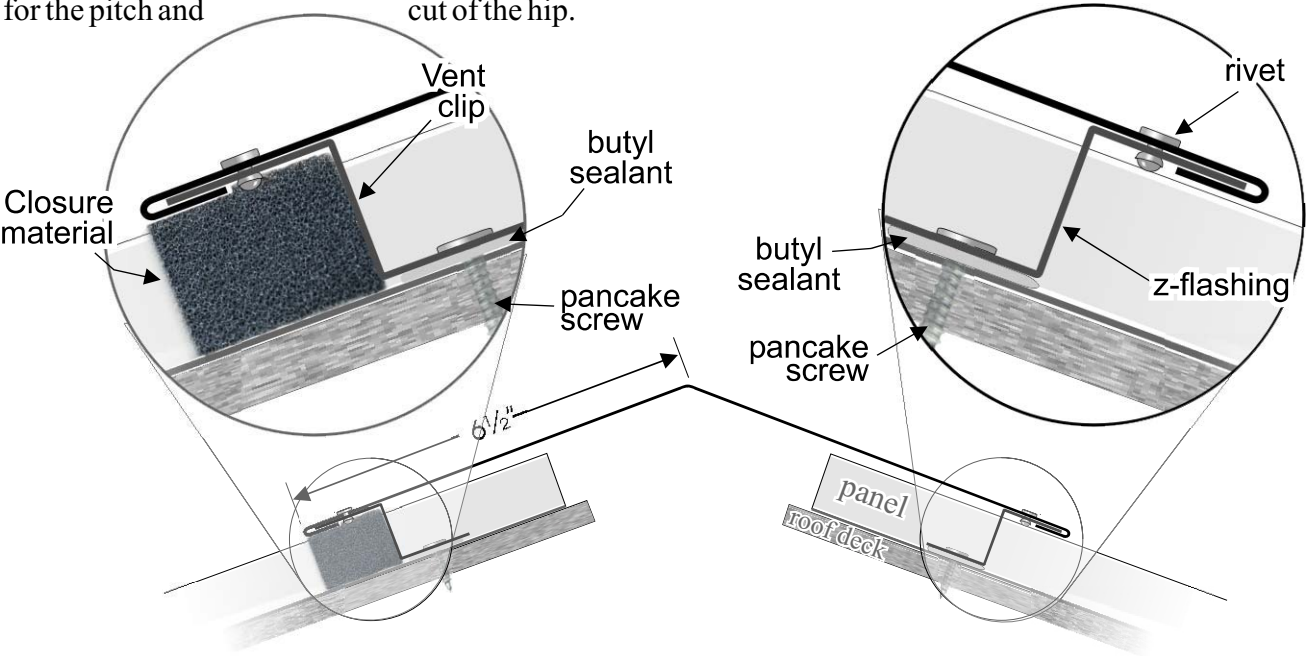

Fig. 11 Ridge caps can be installed as vented (using vent clips and vent material) or sealed (using z-flashing), as shown also in Fig. 12.

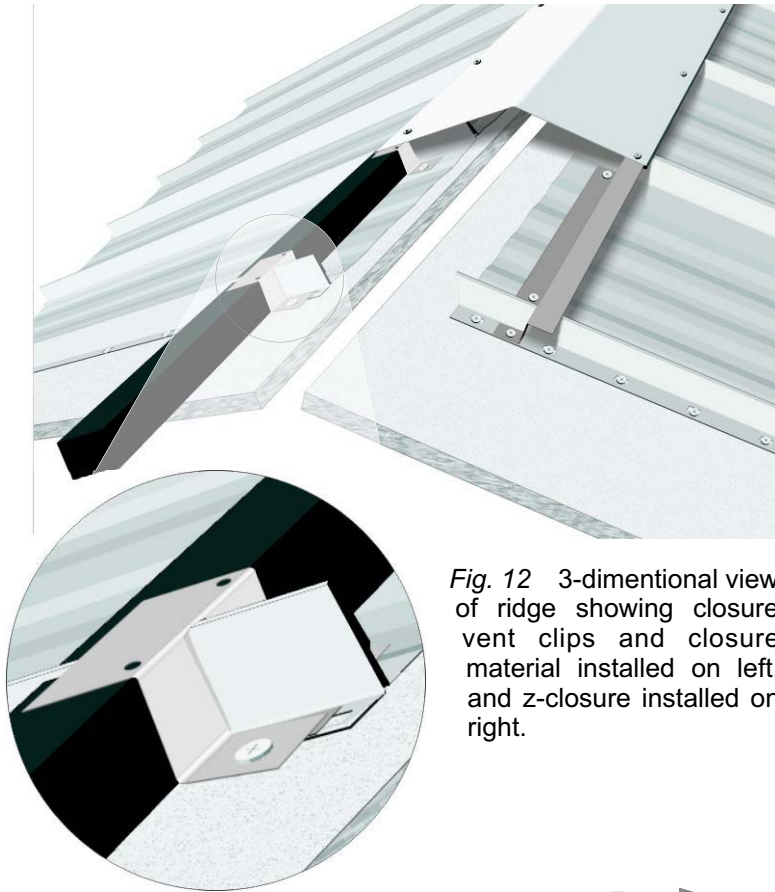

Fig. 12 3-dimensional view of ridge showing closure vent clips and closure material installed on left, and z-closure installed on right.

When attic ventilation is desired, vent clips can be used in the place of z-flashing. Vent clips straddle each rib, and support the ridge cap in much the same manner as the z-flashing. Closure material is inserted between the ribs and sandwiched between the panels and the ridge caps. The decking must of course be cut at the ridge to let out hot air.

Vent material must be cut to the proper length for installation. It is either a sponge-like or fibrous material that prevents wind-driven rain, insects, and leaves and debris from entering the attic, while at the same time allowing the release of hot air out of the attic. Installation may require caulk to hold the material in place.

## Attachment flashings

- *Eave cleats* allow the hidden fastener system to work with drip edge and gable rakes. The factory-hemmed edge of the rake or eave drip fits around the “kick-out” of the cleat, which is attached to the fascia board with pancake screws.
- *Offset cleat* is used to attach the lower ends of hemmed panels over trim above the eave, as with valleys and transition flashing. It is attached with pancake screws and sealed beneath with butyl sealant.
- *Z-flashing* is the basis for attaching five basic trims to the roof. When attaching ridge caps, transition flashing, and endwalls, z-flashing must be notched or cut to fit *between* panel ribs. when attaching gable trim and sidewalls, the z-flashing is not cut, but is mounted parallel to the ribs. Z-flashing must be attached with screws and, to prevent leaks, with butyl tape (or equivalent) underneath.

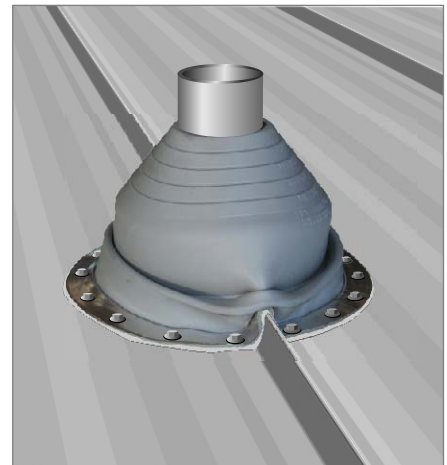
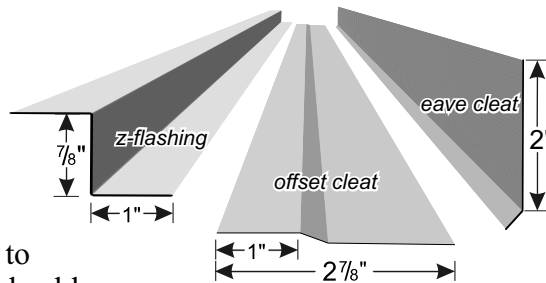

Fig. 13 Pipe Boots provide a watertight seal around roof vents and come in a variety of sizes. They seal with caulk under the base and around pipe, and conform to the shape of the panel ribs.

# Drip Edge & Fascia

Fascia and extended drip edge provide a protective covering for the fascia boards and edges of roof decking at the drip eave of the building. Unlike conventional exposed fastener roofing, drip edge on the standing seam roof also acts as an anchoring device for the lower edges of the panels, allowing a continuation of the hidden fastener system all the way down to the soffit. Fascia are overlapped by eave cleats, which approximately line up with the roof edge of the decking, and are held in place by pancake screws. The extended drip edge has an open hem that hooks on to the cleat at its lower end, and is screwed to the decking on the roof side. Panels are trimmed in a specific manner (see diagram below), bent with a hemming tool, and crimped around the extended eave drip, securing the lower end of the panel. Screws applied to the

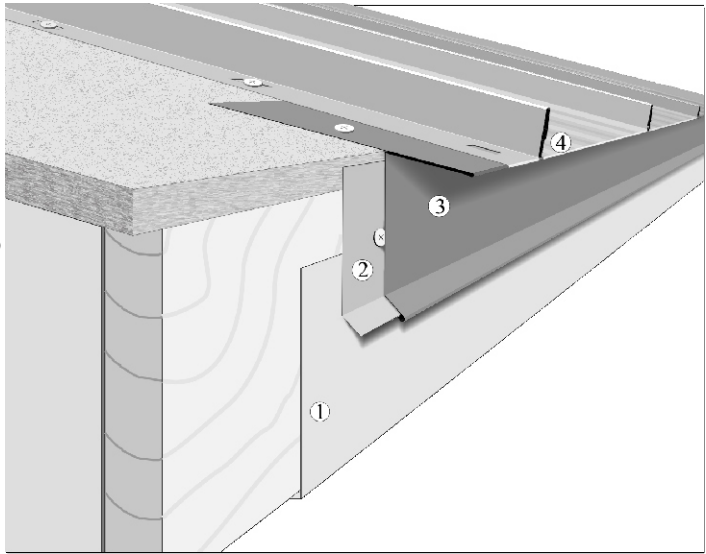

Fig. 14 Layered view of eave, showing fascia (1), cleat (2), extended drip edge (3), and panel (4). Note how the drip edge fits around the cleat, and how the cut panel (which is bent on site by the installer) fits around the “nose” of the eave drip (in actual use, *extended drip edge must match color of panel*).

“nail strip” of the standing seam panel

secure the rest of the length of the panel. The same

hemming procedure applies to valleys and transition flashing,

although these are attached to *roof cleats* instead of the “nose” of the extended drip edge. See valleys and transition flashing (p. 15) for specific details.

When ordering care must be taken to specify the correct pitch of eave drip to avoid either unnecessary effort in applying the trim (if ordered too flat) or drip edge that stands out from the eave (if ordered).

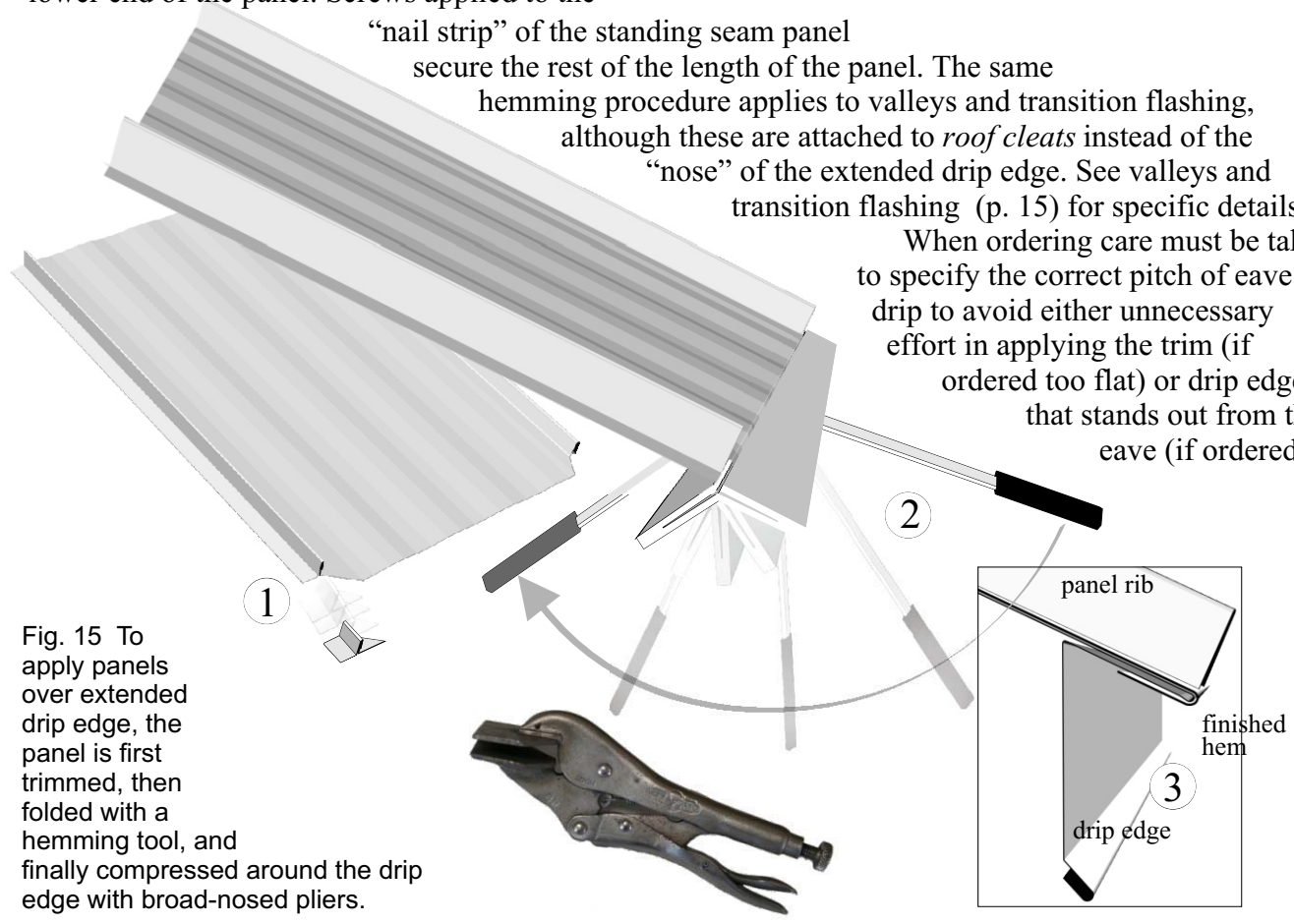
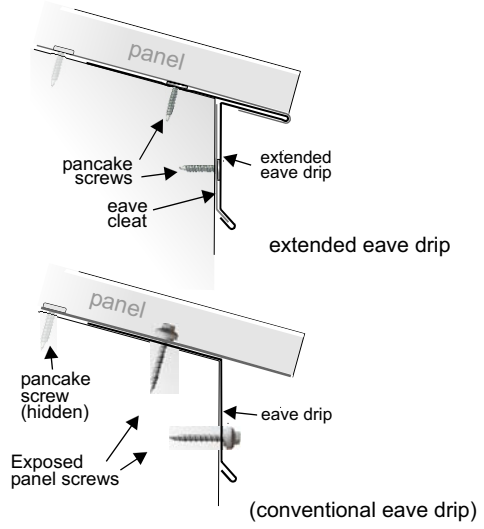

Fig. 15 To apply panels over extended drip edge, the panel is first trimmed, then folded with a hemming tool, and finally compressed around the drip edge with broad-nosed pliers.



too steep). If more than one pitch is involved, specify the number of each pitch (drip edge comes in 10-foot lengths). Order 90 degree drip edge for square-cut eaves.

While the hidden fastener system calls for eave cleats, exposed screws are a simpler and easier-to-install option for drip edge. Surface screws are simply installed at intervals along the face of the trim. Finally, while the remainder of the roof uses hidden fasteners, some installers elect to use screws in the conventional fashion along the eave only of the building. These simplifying procedures both reduce cost and allow faster application of the roofing.

## Gable Flashing

Gable trim serves a similar purpose to eave drip, but acts mainly to protect the exposed edge of the gable end of the building from both wind and rain rather than to serve any function in anchoring panels. The attachment of the eave side has the same options described under *Drip Edge and Fascia*, with regard to cleats vs. exposed screws. For the hidden fastener system, the roof side must be attached to *z-flashing* that runs parallel to the panel ribs and is in turn fastened to the roof with screws and sealed with butyl tape or comparable sealant.

A common option in gable trim is the use of the step rake, which simplifies installation by allowing exposed screws at intervals along its length on the roof side (see diagram below).

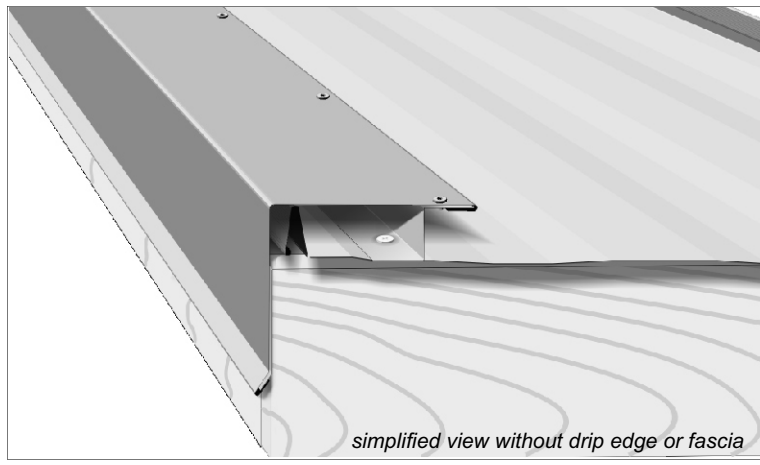

Fig. 16 Standard Gable trim attaches to the z-flashing with rivets and to the fly rafter with either eave cleats (hidden fastener system) or exposed screws. The step rake option is shown below.

Either type of gable trim *must* be fastened to the eave by either eave cleats (with hidden pancake screws) or exposed fasteners.

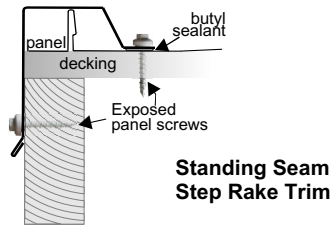
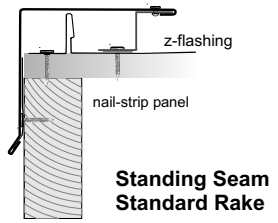
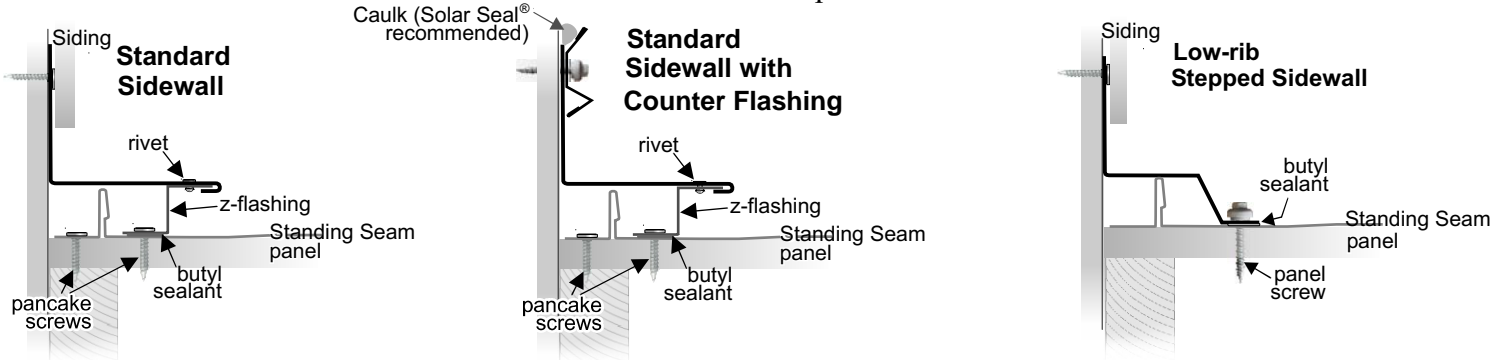



Fig. 17 Standard Sidewall attaches to z-flashing with rivets and is covered on the wall side by siding.

## Side-wall Flashing

Sidewall installation is similar to that of gable trim. As with the gable rake, the standard *sidewall* fastens with rivets to z-flashing installed over the roof panel and, like 8 step rake, *step sidewall* mounts directly to the roof with roofing screws. Either style is attached to the wall with flat fasteners like pancake screws if installed under siding (as shown in figure 17), or with panel screws (using the caulk edge counter-flashed version) if the wall side is exposed to weather. In either case butyl tape (or equivalent) is necessary to seal under either the z- flashing or the panel side of the step rake.



## End-wall Flashing

Installation of endwalls combines principles similar to those described for sidewalls and ridge caps. Z-flashing is either notched or cut in lengths between ribs, and attached with screws and sealant. The endwall is attached to the z-flashing with rivets, and to the wall with screws. When not covered by siding, the counter flashing version is necessary to seal the wall side of the endwall. Specify roof pitch when ordering.

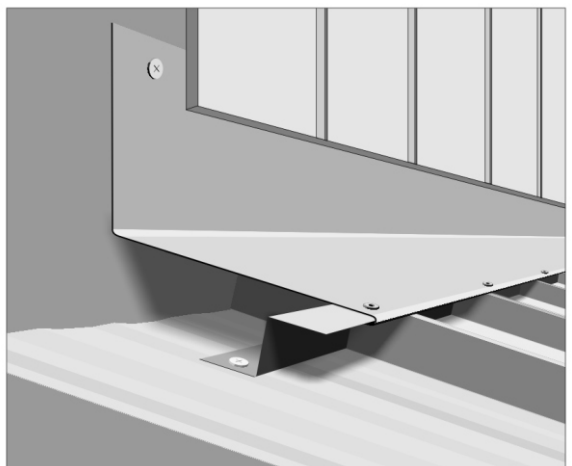
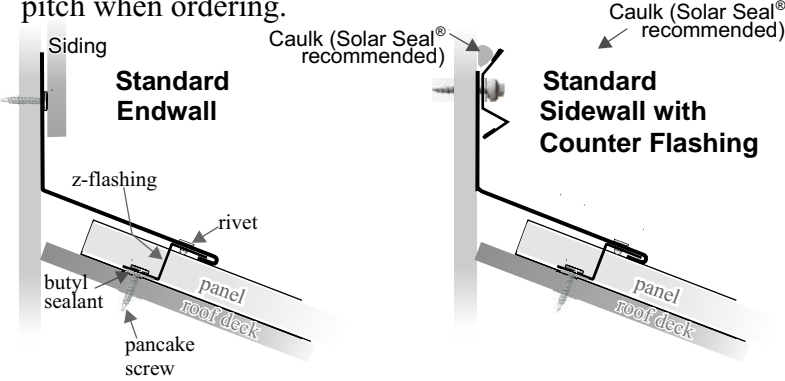

Fig. 18 Endwall flashing is applied where the upper slope of a roof meets a wall.

## Preformed Valley

Panels ending in valleys must be cut and hemmed diagonally and attached to an offset cleat that is screwed down to the roof through the valley (see hemming diagram on p. 12). Because of the amount of water flow in the valley, care should be taken to apply butyl sealant or equivalent between the offset cleat and the valley.

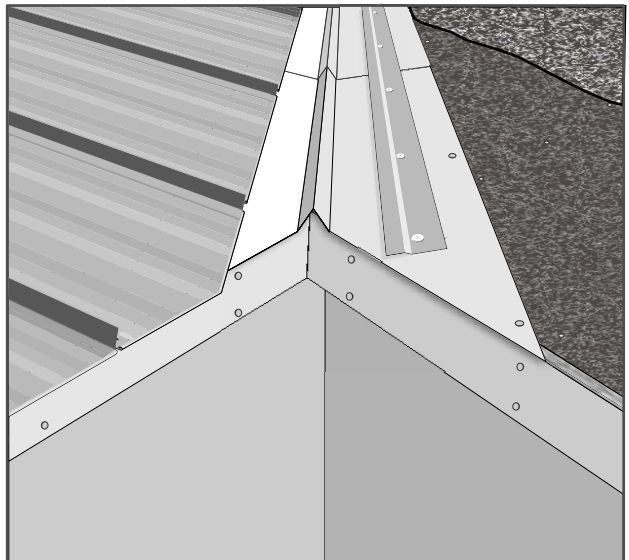
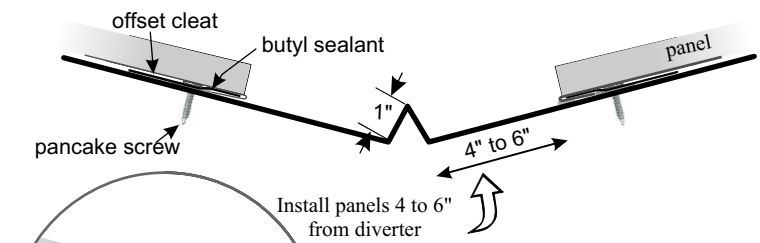

Fig. 19 Diagonally-cut panels are hemmed and attached to offset cleat panels that is mounted on the surface of the valley.

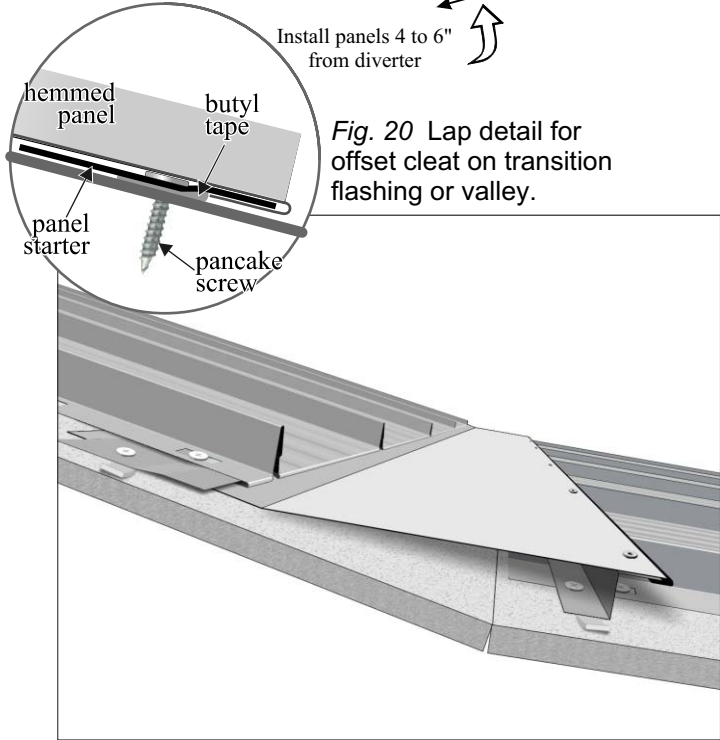

Fig. 20 Lap detail for offset cleat on transition flashing or valley.

## Transition Flashing

Transition flashing is required when a roof makes a change from a steeper to a lesser pitch. The panels of the upper slope are hemmed in the same fashion as they are for drip edge and attached in the same way as valleys to offset cleats. On the lower side, the transition flashing extends over the panels and is attached to z-flashing with rivets. If the lower roof is steeper than the upper section, gambrel flashing is used, mounted in the same way. Be sure to specify both upper and lower pitches when ordering.

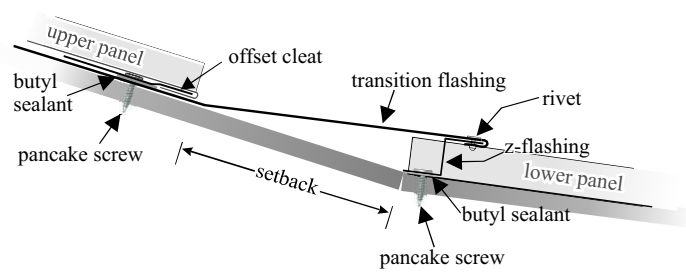
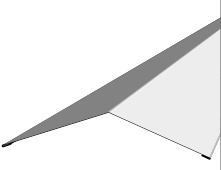
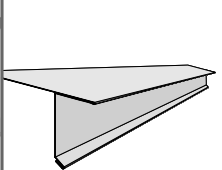
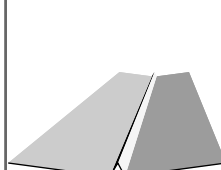
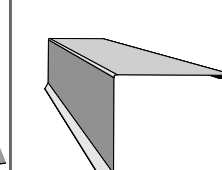
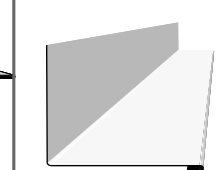
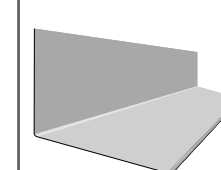
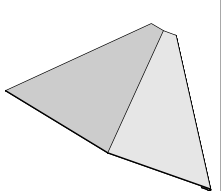
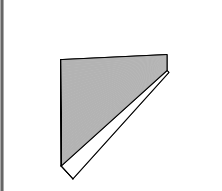
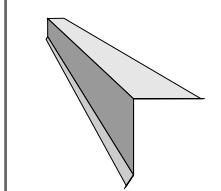
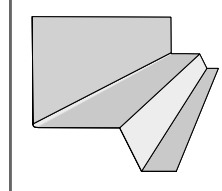
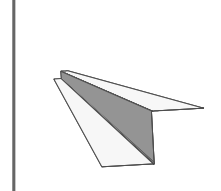
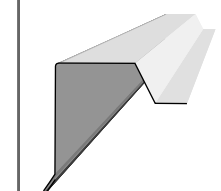
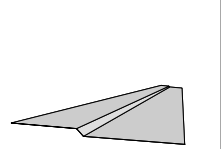









Fig. 21 Transition flashing combines the attachment techniques of valleys (top of page) with that used with ridge caps (p. 10). Notice the panel set-back that allows proper watershed from the upper panels onto the lower. The less the difference in pitch, as well as the flatter the roof, the greater the amount of set-back, and the more need for a longer lower side on the transition flashing.

 Ridge cap (pg. 11)	 Extended eave drip (pg. 8)	 valley (pg. 8)	 Gable rake (pg. 9)	 Sidewall (pg. 9)	 Endwall (pg. 10)
 Transition flashing (pg. 10)	 Cleat	 Eave drip (pg. 8)	 Step Sidewall	 Z-flashing	 Step rake
 Offset cleat	 Rivets	 Pancake screws	 Pipe Boots (pg. 11)	 Solar Seal <sup>®</sup>	 Butyl Tape
 Woodgrip <sup>®</sup> Screws	 Electrical Boots				

### Guide to Misc. Accessories

<i>item</i>	<i>application</i>
<b>pipe boot</b>	Fits over vent and heat pipes. Available also in <i>heat-resistant</i> boots.
<b>electrical boot</b>	Fits around pipes with inaccessible tops (such as weatherheads).
<b>touch-up paint</b>	Hides scratches and mars encountered in installation.
<b>butyl tape</b>	General purpose low-cost sealant, used on panel laps and under trim.
<b>TurboShear HD<sup>®</sup></b>	The best tool for cutting metal roofing panels. Great for angle cuts.
<b>Pancake screws</b>	Used in all applications attaching metal to wood. 1", 1½" sizes.
<b>Stainless rivets</b>	Self-drilling TEK screws for metal purlins. Lap TEK screws draw
<b>Woodgrip<sup>®</sup> screws</b>	Used in applications attaching metal to wood. 1", 1½" sizes.
<b>lifetime screws</b>	Heavy duty coated screws; available in woodgrip and self-drilling.