

How to Install Guide

***Prepare, Install, & Care
for your New Vinyl Siding***

Guide for Traditional and Insulated Siding Installation



Table of Contents

How to Measure	3
Basic Installation Guides	4
Basic Installation Tools & Equipment	5
Cutting the Siding	6
Fastener Choices	6
Preparation	7
New Construction	7
Residing	7
Fastening Procedure	8
Horizontal Siding	9
Obtaining Starting Point	9
Install Corner Posts	9
Starter Strip	10
Windows, Doors and Roof Lines	10
Trim	11
Finish Trim	11
Drip Cap	12
Install Siding Panels	12
Installing Siding Around Windows & Doors	13
Fitting Siding around Fixtures	13
Top of Wall Finish	13
Transition from Horizontal to Vertical	14
Vertical Siding	14
Install Horizontal Furring	14
Install Corner Posts	14
Installing around windows & doors	14
Installing Siding panels	15
Installing Vertical Siding on Gable Ends	15
Determine Roof Angle	16
Soffit & Fascia	16
Ventilation Requirements	16
Install Fascia Cap	16
Examine Configuration	17
Enclosed Overhangs	17
Open Rafters	17
Mitered Corners	18
Fascia	18
Securing Fascia cap to Fascia Board	18
Installation Guidelines for Foam Back Cladding	19
Special Instructions for InsulPlank	19
Special Instruction for SentryPlus	20
Overlapping Panels - InsulPlank & SentryPlus	20
Field Overlaps - InsulPlank & SentryPlus	21
Tips and Tricks for Foam Back Installation	22
Installing in tight spots between windows	22
Installing final course at top of wall	22
Installing final course at peak of gable	22
Installing around fixtures	22
Cleaning saw and knife blades	22
How to Keep you Siding Looking Like New	23
Cleaning Agents Chart	23

Mitten® How to Install Vinyl Siding Guide

The key to successful vinyl siding application is in the planning. Proper installation is the best way to ensure your Mitten vinyl siding lives up to its reputation for quality.

The method of applying vinyl siding and soffit is essentially the same for new construction and residing projects. However, where required, special instructions for new construction and residing are included. In all applications, care should be exercised to properly prepare the structure.

It is recommended that installers review local building codes before starting a project of this nature.

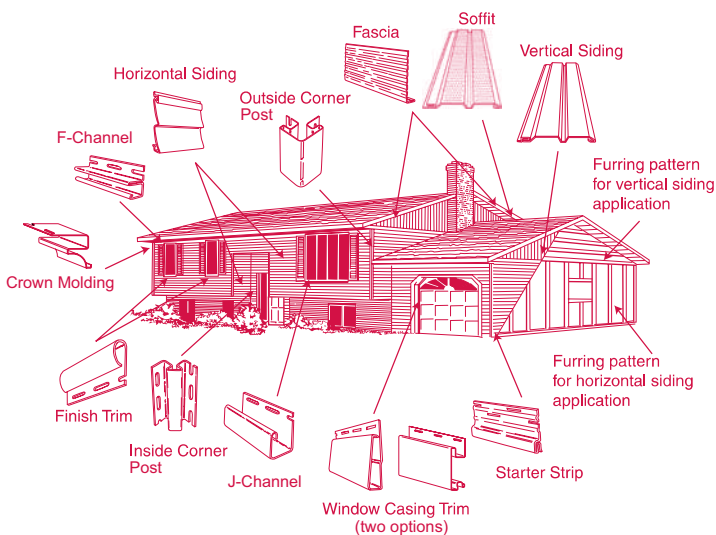

How to Measure

All houses can be broken down into shapes of rectangles or triangles or a combination of both.

The area to be sided can be determined by measuring the height and width of the house including windows.

Total all of the measurements for the areas to be sided. Windows and doors are not usually deducted. Including them will provide an allowance factor for waste. If the windows and doors are extremely large (such as garage or sliding glass doors), some deductions can be made.

Basic Installation Guidelines

Before getting started, it is important to review several common rules for vinyl siding application. Vinyl siding, like all building materials, expands and contracts with temperature changes. The amount of expansion and contraction can be as much as 3/8 of an inch. This expansion and contraction must be accounted for in advance to prevent the siding from buckling which will mar the appearance of your home. The following rules, which come up throughout this guide, are critical for proper vinyl siding installation:

1. Do not store siding in a location where temperatures exceed 130°F or 54°C (i.e. On black top pavement during unusually hot weather or under tarps or plastic wrap without air circulation.)
2. Installed panels must move freely from side to side.
3. When installing a siding panel, push up from the bottom until the lock is fully engaged with the piece below it. Do not force the panels up or down when fastening in position. Stretching the panel upward pulls the natural radius out of the panel and increases the friction of the locks.
4. Always nail in the center of the slot. **WARNING:** Do not nail at the end of a slot! Doing so will cause the siding panel to be permanently damaged. If you must nail near the end of a slot to hit a stud, etc., extend the length of the slot with a nail slot punch tool.
5. Do not drive the head of the nail tightly against the siding nail hem. Allow 1/32" (about the thickness of a dime) clearance between the nail head and the siding panel. Drive nails straight and level to prevent distortion and buckling of the panel.
6. Leave a minimum of 1/4" clearance at all openings and accessory channel stops to allow for normal expansion and contraction. When installing in temperatures below 40°F, increase minimum clearance to 3/8".
7. Do not caulk the panels where they meet the receiver of inside corner posts, outside corner posts, or J-Channel. Do not caulk the overlap joints.
8. Do not face-nail or staple through siding. Vinyl siding expands and contracts with outside temperature changes. Face-nailing can result in ripples in the siding.
9. In residing, furring or removal of uneven original siding may be necessary.
10. In new construction, avoid the use of green lumber as the underlayment. Keep in mind that siding can only be as straight and stable as what lies under it.

Basic Installation Tools and Equipment

Common hand tools, such as a hammer, fine-tooth saw, square, chalk line, level, and tape measure are needed for proper installation. Safety glasses are recommended for eye protection. Other basic tools include:

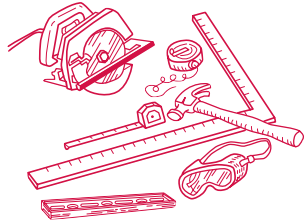

Power Saw

A bench or radial-arm power saw can speed the cutting of the siding. A fine-tooth blade (12 to 16 teeth per inch) should be used with the blade installed in the reverse direction.

Utility Knife

Vinyl is easy to cut, trim and score with a utility knife or scoring tool.

Utility Knife

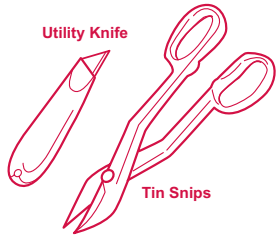

Tin Snips

Tin Snips

Good quality tin snips or compound aviation-type snips will speed the cutting and shaping of the vinyl.

Snap Lock Punch

A snap lock punch is used to punch lugs in the cut edges of siding to be used for the top or finishing course at the top of a wall, or underneath a window.

Snap lock punch



Nail Hole Slot Punch

Occasionally, it may be necessary to elongate a nail hem slot. The hole is elongated to allow for expansion and contraction.

Nail hole slot punch



Unlocking Tool

Remove or replace a siding panel with the unlocking tool. Insert the curved end of the tool under the end of the panel and hook onto the back lip of the butt lock. To disengage the lock, pull down and slide the tool along the length of the panel. Use the same procedure to relock a panel.

Unlocking tool



Cutting the Siding

When cutting vinyl siding, follow these guidelines:

Safety goggles are always recommended for all cutting and nailing operations. As on any construction job, use proper safety equipment and follow safe construction practices.



With a circular saw, install the fine-toothed (plywood) blade backwards on the saw for a smoother, cleaner cut, especially in cold weather. Cut slowly.



CAUTION! Use of a backwards blade on any other materials could be unsafe.

With tin snips, avoid closing the blades completely at the end of a stroke for a neater, cleaner cut.

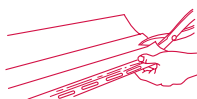

With a utility knife or scoring tool, score the vinyl face up with medium pressure and snap it in half. It is not necessary to cut all the way through the vinyl.

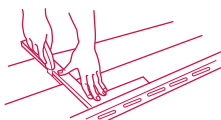

Fastener Choices

Use aluminum, galvanized steel, or other corrosion-resistant nails, staples or screws when installing vinyl siding. Aluminum trim pieces require aluminum or stainless steel fasteners. All fasteners must be able to penetrate not less than 3/4" into framing or furring.

Nails

Nail heads should be 5/16" minimum in diameter. Shank should be 1/8" in diameter.

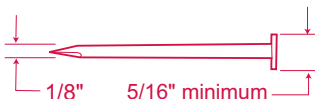

Screws

Screws must be centered in the slot with a minimum 1/32" space between the screw head and the vinyl. Screws must be able to penetrate not less than 3/4" into framing or furring and should be: Size #8, truss head or pan head, corrosion-resistant, self tapping sheet metal type.

Staples

If staples are being used instead of nails or screws, they must:

- Not be less than 16 gauge semi-fattened to an elliptical cross-section
- Penetrate not less than 3/4" into framing or furring
- Be wide enough in the crown to allow free movement of the siding (1/32" away from the nailing hem).

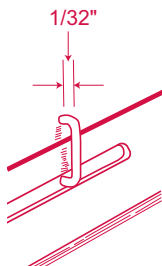

Preparation

Inspect and plan the job in advance. Check surfaces for straightness and fur when necessary. Surfaces should be uniform and straight from various viewing angles.

To achieve designed performance, vinyl siding must be installed over a weather resistant barrier system that includes a continuous weather resistant material and properly integrated flashing around all penetrations and where vinyl siding interfaces with other building products such as brick, stone, or stucco. Always consult the applicable building code for minimum weather barrier requirements in your area. Keep in mind that additional measures may provide better protection against water intrusion than the minimum requirements of the building code.

New Construction

Be sure all nails and sheathing are in place. Waterproof sheathing paper is recommended under new construction or if old siding is removed. Consult your local building code.

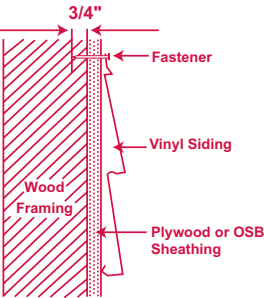

New Construction

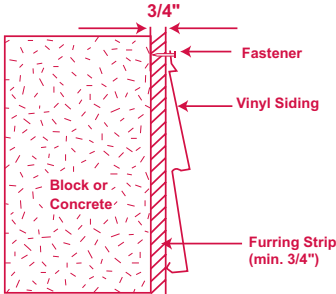

Over Block or Concrete

Residing

Nail down all loose boards and replace any rotten ones. Remove shutters, downspouts, lighting fixtures, moldings, old caulking around doors and windows. Vinyl siding MUST be applied over a rigid sheathing that provides a smooth flat surface and provides sufficient thickness to support the nail. The use of Levelwall insulation will assist.

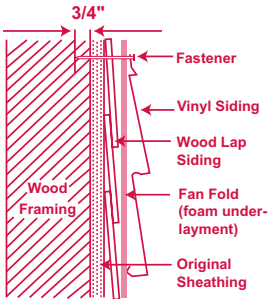

Residing

Fastening Procedure

Vinyl siding can expand and contract 1/2" or more over a 12'6" length with changes in temperature. Whether using a nail, screw, or staple to fasten the siding, the following basic rules must be followed:

- Make sure the panels are fully locked along the length of the bottom, but do not force them up tight when fastening.
- Do not nail or staple through face of siding. This may result in ripples in the siding.
- Do not drive the head of the fastener tightly against the siding nail hem. Leave a minimum of 1/32" (the thickness of a dime) between the fastener head and the vinyl.
- **Tight nailing, screwing or stapling will cause the vinyl siding to buckle with changes in temperature.**
- When fastening, start in the center of the panel and work towards the ends.
- Center the fasteners in the slots to permit expansion and contraction of the siding.
- Drive fasteners straight and level to prevent distortion and buckling of the panel.
- Start fastening vertical siding and corner posts in the top of the upper most slots to hold them in position. Place all other fasteners in the center of the slots, spacing the fasteners a maximum of 16" apart for horizontal siding, every 12" for vertical siding and every 8" to 10" for accessories.

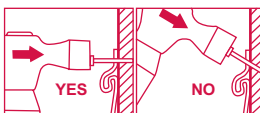
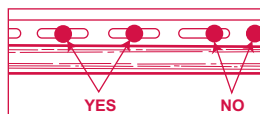
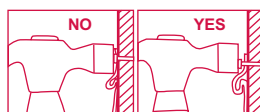
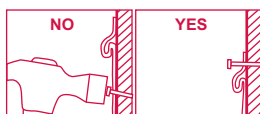
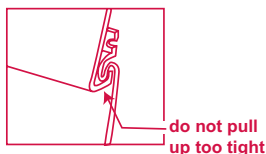

Application for high wind areas.

Using a 5/8" nylon washer with a 1/4" hole between the nail and siding, you can increase the wind load capabilities of your siding installation.

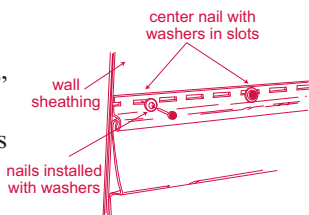

Horizontal Siding

Step 1

Obtaining Starting Point

The first step is to determine where you will apply the first course of siding. This can be at the same level as the old siding or, on new construction, at a level that will cover the edge of the foundation. Use a chalk line and a level to obtain a horizontal starting point so that all installed siding will be perfectly level. At all corners, use a plumb line to ensure that corner posts are vertical.

Follow these steps in the order shown for the easiest and best application.

Step 2

Before the siding itself can be hung, a number of accessories must be installed first including starter strip, corner posts, window flashing, trim and J-Channel over the roof lines and at top of walls.

Install Corner Posts

Cut post to the length required allowing 1/4" gap between the top of the post and the eaves or soffit. Begin nailing at the top of the upper slot on both sides of the corner post, hanging corner post in position. The balance of the nailing must be in the center of the slots at 8" to 12" on center. If more than one length is required, refer to the following note for cutting and overlapping instructions.

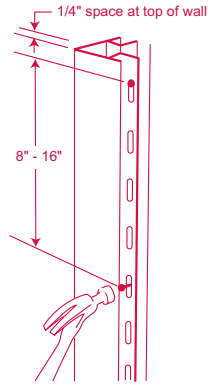

Note

- *Overlap the upper piece over the lower piece by cutting away 1" of the nailing flange on the top piece. Overlap 3/4", allowing 1/4" for expansion.*
- *This method will produce a visible joint between the two posts, but will allow water to flow over the joint, reducing the chance of water infiltration.*

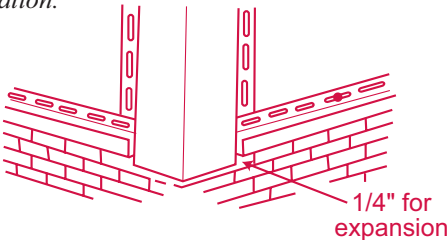
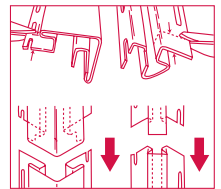

All corner posts should be cut to appear same and should extend 1/4" to 1/2" below first course of siding.

Step 3

Starter Strip

In order for the siding to be installed in a level fashion, the starter strip at the bottom of the wall must be level. With a tape measure, measure the width (w) of the starter strip.

Determine, as explained in Step 1, where the bottom of the first course will begin. Measure up from this mark, the width of the starter strip, less 1/2", and chalk a level line across the wall.

Using the chalk line as a guide, install the top edge of the starter strip along the bottom of the chalk line, nailing at 10" intervals.

Keep the starter strip 1/4" from the nail hems of both the inside and outside corner posts. Leave 1/2" gap between ends of adjacent starter strips to allow for expansion.

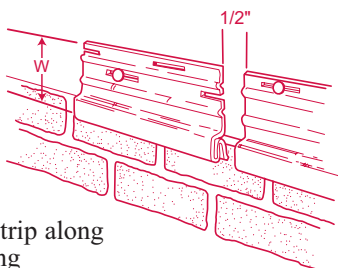

Step 4

Windows, Doors and Roof Lines

Window Flashing

Apply the flashing on the underside of the window first. Follow this application with flashing on the sides of the window. Make sure to overlap the bottom flashing. The flashing should be long enough to direct water over the nail flange of the last course of complete siding panels.

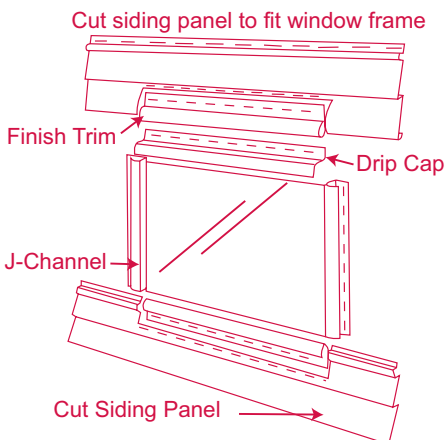
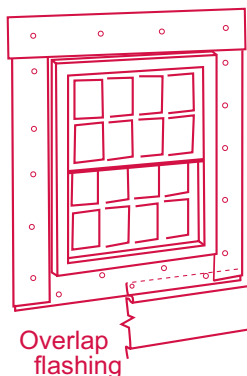

Trim

J-Channel trim or Window Casing trim is used around windows and doors to receive the siding. Using cuts 1 and 2, follow the steps below when applying trim.

- Using Cut 1, bend the tab of the top piece of trim down to provide flashing over the side trim. (Illustration A)

- Cut 1 can be used at the bottom end of the side piece of trim. Fold tab inward at the bottom of the window to prevent water from entering under the sill. (Illustration B)

- Cut the top trim longer than the width of the window or door and notch the channel at the top using Cut 1.

- Notch Cut 2 the side members and overlap top channels. The trim should fit snug to the window.

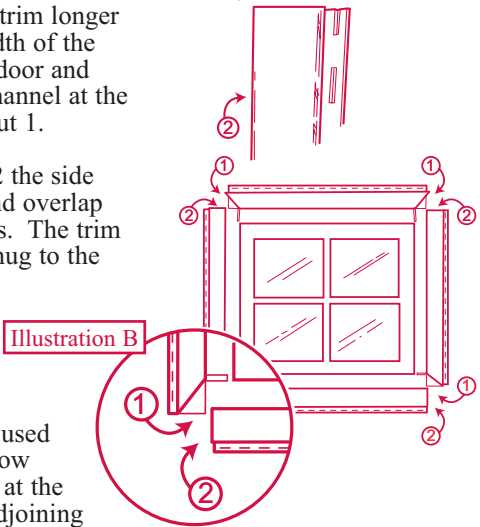
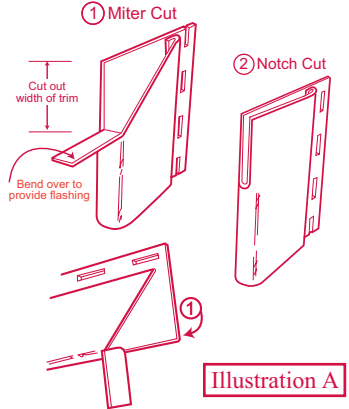

Finish Trim

This trim is used above and below openings, and at the top of walls adjoining soffits. Finish trim can be furred out to preserve the proper panel angle. Apply a furring strip to the wall, butting it to the underside of the windowsill. Install the finish trim, extending it past either side of the window, as far as the outer edge of the J-Channel face. Finish trim is also used in an inverted position over the tops of the windows and doors and where trims butt against window framing. Caulk where J and sill trims meet the opening frame.

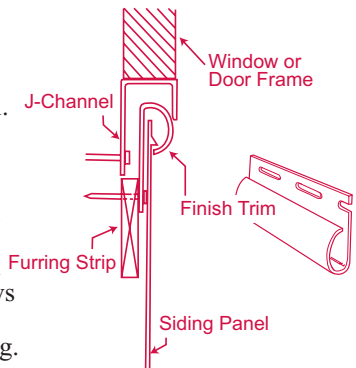

Drip Cap

The drip cap is nailed above the window and door and extended on either side, flush with the exposed leg of the J-Channel. A tab is cut at either end of the drip cap and bent down over the J-Channels.

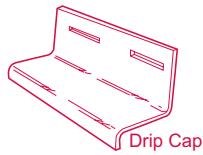

If required to maintain panel angle, a furring strip is nailed over the drip cap.

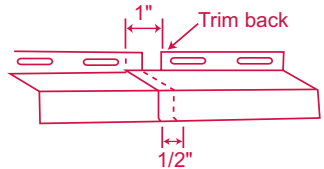

Step 5

Install Siding Panels

The first siding panel is engaged in the starter strip and nailed. If the siding can be moved laterally after it has been locked up, a positive lock has been achieved. Continue nailing on 16" centers (and not over 8" centers in high wind areas). Leave 1/4" or 3/8" of space where siding fits into accessories to allow for expansion. When installing below freezing – leave 1/2".

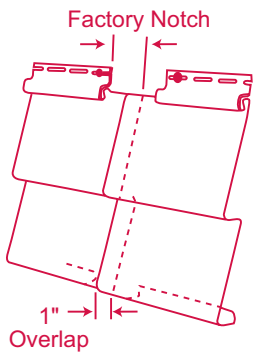

Overlap the vinyl panels half the dimension of the factory notch.

For good appearance, laps should be away from traffic areas and staggered horizontally a minimum of 2' from one course to the next. Do not "repeat" and overlap in on vertical line for a minimum of 3 courses. When overlapping do not nail closer than 6" from the ends of both panels.

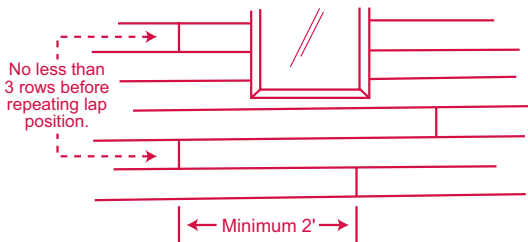

Installing Siding Around Windows and Doors

To fit the siding under windows and doors or under the eaves, measure the distance from the bottom edge of the lock on the finish trim to the bottom edge of the top lock of the last full siding panel. Add 5/8" to this measurement to allow the panel edge to engage in the finish trim.

- Cut the siding panel to the adjusted measurement under the windows or at finish of siding installation.
- Using the snap lock punch, punch ears in the trimmed edge of the siding panel at 8" intervals. Be sure the "ears" face outward from the wall.
- Lock the top edge of a siding panel in the finish trim and secure the lock at the lower edge of the panel.

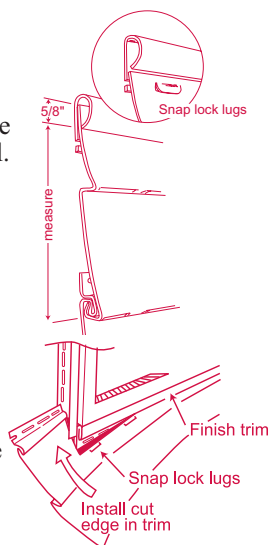

To fit the siding over the top of windows and doors, cut out the bottom section of the panel leaving 3/8" clearance on both sides of the window, so that the horizontal edge of the cut out fits firmly into the finish trim.

Fitting Siding Around Fixtures

For handling protrusions around the wall, manufacturer's accessories specifically designed to fit around protrusions can be installed or you can cut siding panels to match the shape and contour of the obstruction

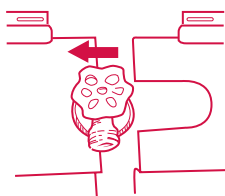

Always begin a new course of siding at the fixture to avoid excess lap joints.

Cut a slot 1/4" larger than the fixture.

Step 6

Top of Wall Finish

Siding is measured and finished off at the top of the wall in exactly the same fashion as under a window or door, as explained in installing siding around windows and doors, except that full sheets of siding will be used.

To finish siding on gables install a J-Channel along the gable angle against the soffit. Cut siding to the proper angle and install siding in the J-Channel, leaving a gap for expansion.

Transition from Horizontal to Vertical

Finish the last course of horizontal siding with the J-Channel and/or Finish trim. Install a drip cap and a J-Channel (or H-Trim). The top piece of J-Channel must have 1/4" weep holes drilled every 24" to allow for water runoff.

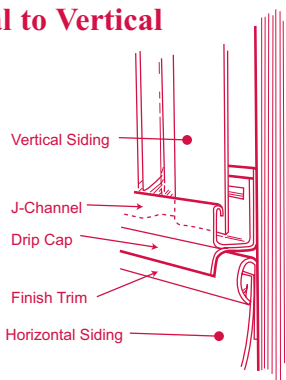

Vertical Siding

Plan panel layout. Read steps 1 through 6 of Horizontal Siding Instructions for basic rules and tips of a standard siding application.

Drill drainage holes every 12" in bottom edge of J-Channel.

With vertical accessories and panels, position the first nail at the upper edge of the top nailing slot. This allows the panel to hang. Position the remaining nails in the center of the nailing slot. See fastening procedures on page 8.

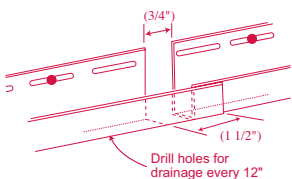

Step 1

Install horizontal furring strips 12" on center or a solid nailable sheathing prior to the siding, if needed, to level the surface or provide sufficient material for 3/4" fastener penetration.

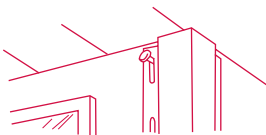

Step 2

Establish the vertical starting base line. Install corner posts even with or slightly below the chalk lines. J-Channel should extend into corner post. (Remember to allow 1/4" for expansion)

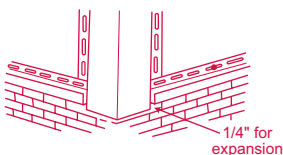

Step 3

Install J-Channel around windows and doors and along eaves. The J-Channel at the top of the opening should extend over side of J-Channel by 1/4". Cut and bend this top portion down over this side of J-Channel. (This will allow water to run off)

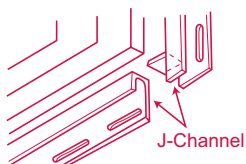

Step 4

For ease of application, vertical installations should start at a corner. Fill the channel of the corner by nailing down a strip of board 2" wide. Push a strip of finish trim into the channel of the corner over the board.

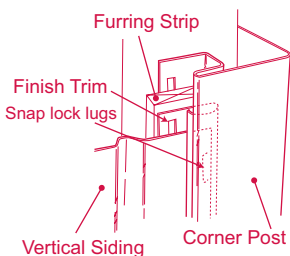

Cut off the locking leg of the first panel, and Snap-Lock Punch the edge at 12" intervals. Make sure the 'ears' face outward from the wall.

Push the punched edge of the panel into the strip of finish trim and nail into place. Interlock and nail subsequent panels. Measure and cut to size the last panel, punch the edge and insert into the finish trim in the corner.

Note: Before installing any siding, measure the width of the wall to ensure that the last panel will fit into finish trim in the corner.

Installing Vertical Siding on Gable Ends

For a clean look, you want to have the groove of the vertical panel centered in line with the peak of the gable.

- Start by trimming the perimeter of the gable with J-Channel, overlapping joints. If horizontal siding is installed below vertical, see previous page for illustration.
- At the peak of the gable, drop a chalk line perpendicular to the starter strip. You can either start in the center using H-Trim and starter strip each side or from corner across. To ensure a balanced look, determine where to start the first panel—measure from the chalk line along the starter strip until you get to a point where the measurement to the J-Channel is less than a panel width.
- Mark that point with a pencil.
- Measure back toward the center of the gable from that point $1\frac{1}{4}$ ", and draw a vertical line, parallel to the line dropped from the gable peak. This line is the position of the edge of the nail hem on the first panel.

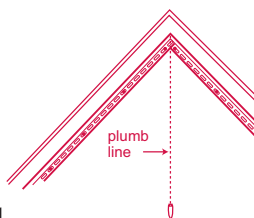
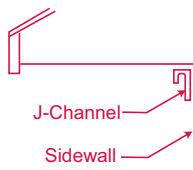

Determine Roof Angle

Every 3 panels be sure to check for plumb and also measure to the center chalk line to ensure that you are going to arrive at the peak with a center groove in line with it. Make needed small adjustments by pushing the panels "in" or "out" within the lock. The lock should face away from the general viewing area.



Use a piece of siding, draw line here to reflect angle of roof onto siding

Note: Over roof lines install J-Channel to sit 1/2" off of shingles, not directly on the shingle surface. A piece of J-Channel can be used as a spacer template.

Soffit and Fascia

Ventilation Requirements

Proper attic ventilation is important for any home. Consult your local building code or official for the appropriate requirements for your specific area and use vented soffit or other vented products as necessary.



Step 1

When installing soffit, the object is to provide 2 parallel slots, one on the house and one on the bottom of the Fascia board that will support the soffit panel. Depending on your truss and Fascia board configuration, there are several options for installation of Fascia cap and receiving channels for Soffit. Fascia cap with J or without J can be used with accessories such as J-Channel and F-Channel.

Step 2

The best approach is to select a method that works most effectively with the construction techniques used.

Examine the illustrations and install the receiving channels in a configuration that closely resembles the construction techniques in your project.

Channels should be nailed every 12" to 16".

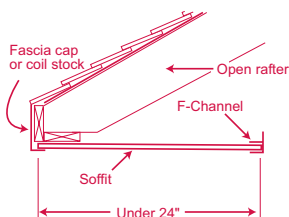
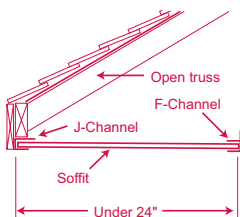

Step 3

Enclosed Overhangs

For soffit applications with enclosed overhangs, start by installing 1/2" or 5/8" J-Channel along wood fascia board and on wall edge level to bottom of Fascia board. Nail

J-Channel every 8"-10". Cut Soffit panels 1/4" shorter than dimension "A" and fit into place, locking panels together. Fasten with nails.

If you are removing existing wood soffit or molding, you may need to level area with a 1" by 2" furring strip.

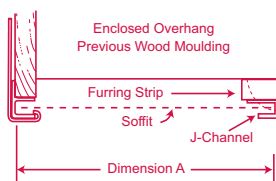

Step 4

Open Rafters

To install soffit on an open rafter overhang, F-Channel is attached to the wall face and either F-Channel or Fascia with or without "J", is attached to fascia board. Soffit is then cut to width of opening and suspended between.

For rafter widths greater than 24", we recommend a center fastener support should be provided. This can be provided by nailing 2 X 4's from fascia to wall face every 3 rafters then attaching a 1 x 2 flat along bottom of these support hangers. Soffit panels can be screw-nailed into this support.

Corners may be squared off or mitered.

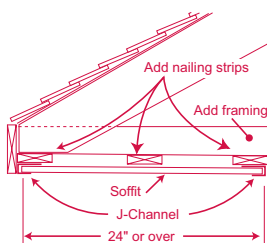
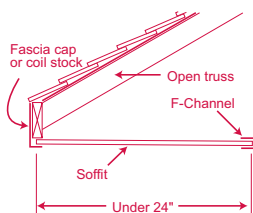

Step 5

Mitered Corners

Install H-Trim or 2 J-Channels on diagonal, then cut soffit panels to fit angle.

For "best" appearance, cut mitered soffit panels so that center v-grooves line up. Porch ceilings may be covered with non-ventilated soffit panels. If ceiling is wider than 12'0" an H-Trim can be used to provide a seam.

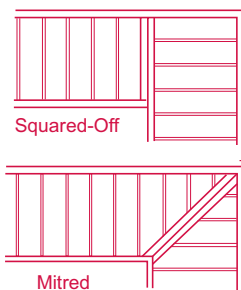

Step 6

Fascia

Finish Trim is installed around the top perimeter of the wood Fascia Board.

Measure the width of the face to the finish trim and add 5/8" to insert into Finish Trim.

Overlap adjacent lengths of fascia by approximately 1". To do this, cut away a 1-1/2" section from the bottom part of the underlying fascia. It is necessary to nail through one end of each Fascia panel so as to fix its position. Position the anchor nail as shown in diagram so that the overlapping Fascia cap will cover the nail. Be sure to drill a 3/16" pilot hole for this nail.

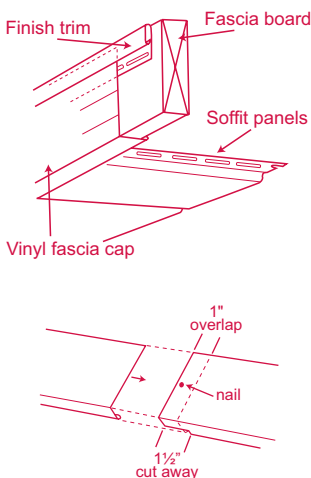

Step 7

Securing Fascia cap to Fascia Board

If you are installing Fascia without J, this is one of the rare instances that face nailing is allowed. Drive the nail through the "V"-shaped groove in the soffit panel using small-headed nails.

Once the soffit is face nailed to the Fascia cap it will expand in one direction - toward the receiving channel opposite. Allow space for expansion of soffit.

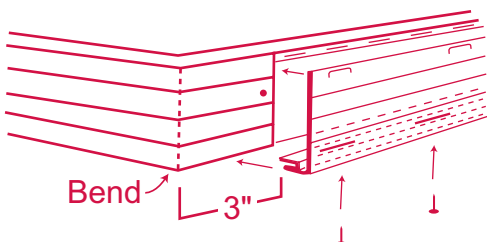

Installation Guidelines for Foam Back Cladding

It is important that foam back products, in particular, InsulPlank and SentryPlus be given the full tolerance available for expansion and contraction. Follow these guidelines to ensure the products will maintain a level and flat, "just installed" appearance for years to come.

- Please refer to the basic guidelines on page 4 as they apply to foam back cladding installation as well.
- Mitten designed foam back cladding accessories must be used on all InsulPlank and SentryPlus installations.
- Do not nail or fit the panel tightly.
- When installing between outside corner and J Trim, insert the panel in the corner post first, then open the face of the J Trim and insert. The same steps are required between two J Channels or an Inside Corner and J Trim.
- The 1 7/8" face Undersill Trim is used on the bottom of windows or at the top of the wall when the last course is being installed.
- The foam is glued to within 2.5" of the end of the factory cut to allow the overlap to be tucked behind the foam for a perfect lap.
- The foam must be butted tight to achieve maximum R-value. Make sure the panels slide freely when engaged with the foam.

Special Instructions for InsulPlank

The D6" InsulPlank panel employs patented top-loading stack lock technology.

When engaging the StakLoc, "snap" the panel into place allowing the panel to use it's own weight to set in perfect position. If your installation has been leveled correctly the Stakloc will automatically level every time.

Do not use downward force on the panel after the "snap".

Do not nail or fit the panel tightly. Check to make sure every panel moves freely. Reset the panel to the middle of the nail slot.

When engaged properly the Stakloc should look as it does in Figure 1.

Be sure to use StakLoc® starter strip for InsulPlank, as traditional starter will not work. The starter strip requires nailing in the top and bottom slot every 16" to maximize the windload performance.

Figure 1 -- Fit to Click

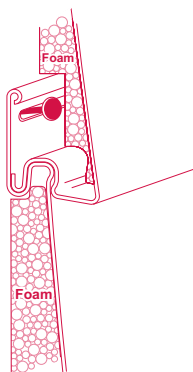

Special Instructions for SentryPlus

When installing traditional locking siding panels, such as SentryPlus, push up from the bottom until the lock is fully engaged with the piece below it. Do not force the panels up or down when fastening in position. Stretching the panel upward pulls the natural radius out of the panel and increases the friction of the locks. Be sure to use Foam Back Starter strip as traditional starter will not work.

Overlapping Panels--InsulPlank & SentryPlus

- Factory notches should be used for all overlaps where possible.
- The foam is glued to within 2.5" of the end of the factory cut to allow the overlap to be tucked behind the foam for a perfect lap.
- Foam must be butted tight to achieve maximum R-value. Make sure the panels slide freely when engaged with the foam. View Figures 2, 3, & 4.

Figure 2 -- Use Factory Notches (Rear View)

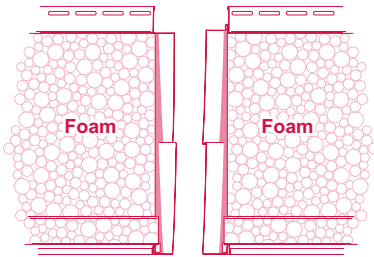

Figure 3 -- Butt Foam Tight (Rear View)

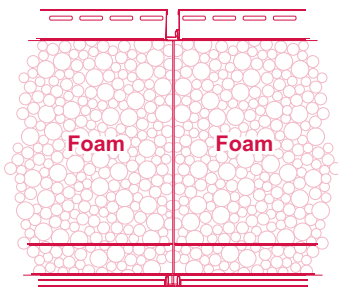
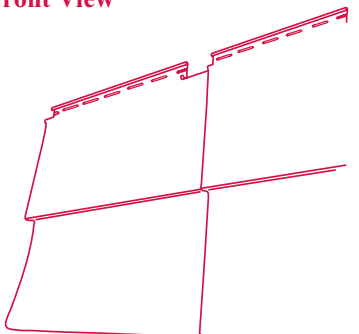

Figure 4 -- Front View



Field Overlaps--InsulPlank & SentryPlus

If you need to cut a “field” overlap you must:

Figure 5 -- Field Overlap

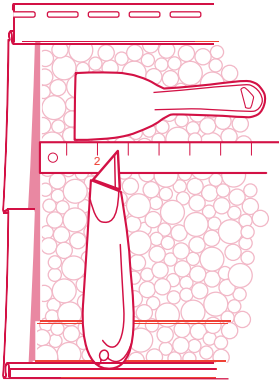

a) Trim and remove the foam 1” back from the siding end (Figure 5).

b) Clean the adhesive tracks using a paint scraper to ensure a proper lap (Figure 6).

Remove all foam particles and adhesive residue



Figure 6 -- Field Overlap

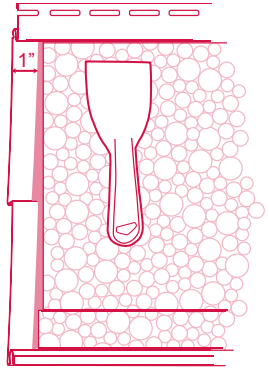
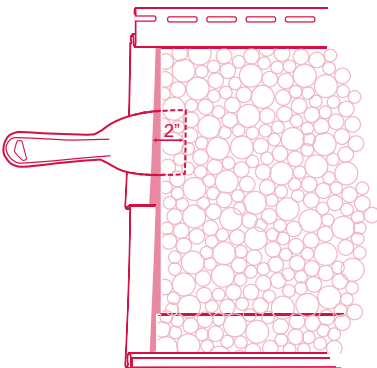

Figure 7 -- Field Overlap



c) Slip the paint scraper between the foam and the panel (Figure 7) approximately 2”, creating an insert similar to the factory joint illustrated in the ‘Overlapping Panels’ section.

Slip paint scraper between foam and panel 2”

d) Insert the panel as illustrated in the ‘Overlapping Panels’ section making sure all free foam particles are removed so they won’t get behind the panel and cause surface distortion. Make sure the panel slides freely once inserted behind the foam.

Tips and Tricks for Foam Back Installation

Installing in tight spots between windows

- Place a nail at the bottom of each of the two vertical J-Channels between the windows to hold them in place.
- Leave the remaining nail slots free of nails for the moment. This allows the installer to flex the J-Channels in order to slide the next insulated panel into place.
- After each panel is installed, put another nail into the J-Channels and repeat.

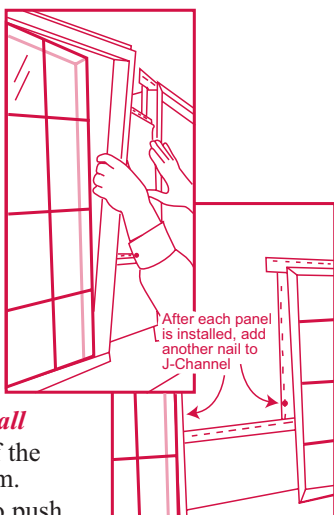

Installing final course at top of wall

- Leave 1/4 inch space at the top of the vinyl course inside the finish trim.
- This should allow the installer to push the panel up against the top of the finish trim and then set in down on top of the StakLoc.

Installing final course at peak of gable

- Cut the panel to the desired measurements.
- Cut out a notch in the foam insulation.
- This will allow the small triangular shaped foam backed panel to bend or flex allowing it to fit up into the J-Channel and then snapped down into the StakLoc.

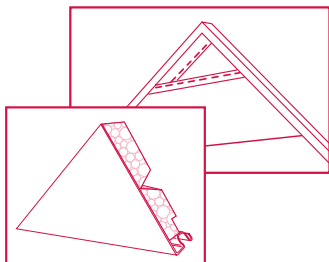

Installing around pipe protrusions, etc.

- Begin a new panel at the fixture.
- Cut to match the shape of the fixture.
- Make the cut 1/4" larger than the fixture. **NOTE:** If available, use a commercially manufactured trim ring or fixture mount.

Cleaning Saw and Knife Blades

- Use mineral spirits to wipe your blades clean as they begin to accumulate adhesive residue or vinyl particles.
- At the end of the day, remove the saw blade from the circular saw and allow it to soak for a short time in this solvent to loosen any residue build-up.

How to Keep Your Siding Looking Like New!

While Mitten Inc. Solid Vinyl Siding comes closer to being totally maintenance free than any other siding on the market today, it will become dirty just as a freshly painted house, new automobile or any other product which is exposed to atmospheric conditions. Generally, your Mitten vinyl siding can be cleaned satisfactorily through the use of an ordinary garden hose. If this does not do the job, then we suggest the following:

1. Equip a garden hose with a soft bristled, long handle car brush. Avoid using stiff bristle brushes or abrasive cleaners, which may change the gloss of the cleaned area and cause the siding to look splotchy.
2. Where soil is of a stubborn nature, (as frequently found in industrial areas) the following cleaning solution works well: 1/3 cup detergent (Tide as an example) + 2/3 cup trisodium phosphate (Soilax as an example) + 1 gallon of water.

In certain geographic areas where mildew may be a problem, substitute one quart of 5% sodium hydrochloride (Clorox for example) for one quart water in the above formula.

Where the house is extremely dirty, it is recommended that you start washing from the bottom and go to the top, rinsing frequently. Cleaning solutions should be permitted to stand on the surface of the siding for several minutes before rinsing.

STAIN	CLEANERS*
Bubble Gum	Fantastik, Murphy's Oil Soap, or solution of vinegar (30%) and water (70%)
Crayon	Lestoil
DAP (Oil-based caulk)	Fantastik
Felt-tip Pen	Fantastik or water-based cleaners
Grass	Fantastik, Lysol, Murphy's Oil Soap or Windex
Lithium Grease	Fantastik, Lestoil, Murphy's Oil Soap or Windex
Mold and Mildew	Fantastik or solution of vinegar (30%) and water (70%)
Motor Oil	Fantastik, Lysol, Murphy's Oil Soap or Windex
Oil	Soft Scrub
Paint	Brillo Pad or Soft Scrub
Pencil	Soft Scrub
Rust	Fantastik, Murphy's Oil Soap or Windex
Tar	Soft Scrub
Top Soil	Fantastik, Lestoil or Murphy's Oil Soap

Follow the precautionary labeling instructions on the cleaning agent container. Protect shrubs from direct contact with cleaning agents.

Mitten does not endorse proprietary products or processes and makes no warranties for the products referenced herein. Reference to proprietary names is for illustrative purposes only and is not intended to imply that there are not equally effective alternatives.



NOTE: No instruction guide can anticipate all the questions or scenarios that might arise during a siding or soffit installation. We have provided the tools and techniques used to complete a typical installation. Should you encounter an installation problem not covered in this guide, we suggest you contact your installing contractor or for additional help contact a Mitten Inc. Customer Service representative or visit VSI website for detailed instructions. www.vinylsiding.org