



Edco Steel Siding Install Guide

Traditional Lap, Dutchlap, Vertical Board & Batten

800-728-4010
bestbuymetals.com

STEEL SIDING, ACCESSORIES & EQUIPMENT

Listed below are the five styles of Edco steel siding. Also, below are the accessories that might be needed to complete a job.

At the bottom of the page are some of the tools that you might need to finish a job.

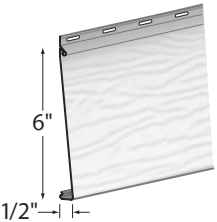
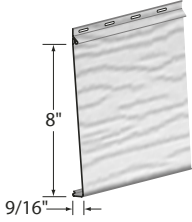
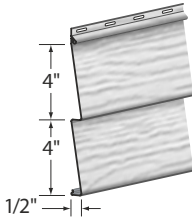
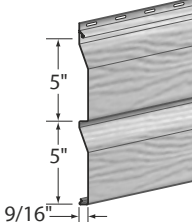
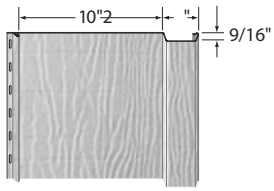
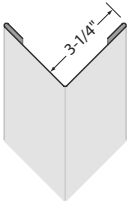
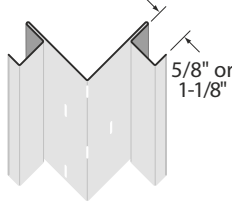
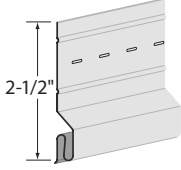
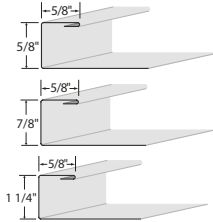
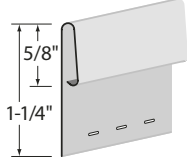
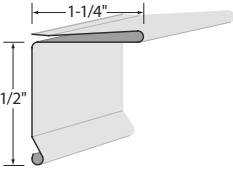
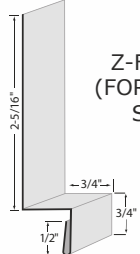
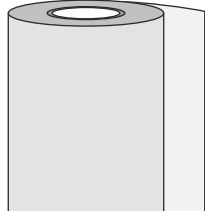
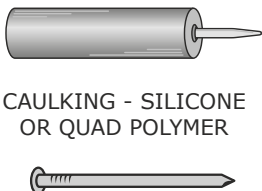
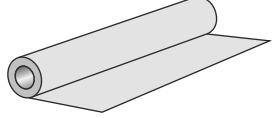
 <p>6" TRADITIONAL LAP STEEL SIDING 29 GA PVC, ENTEX OR PRISM</p>	 <p>8" TRADITIONAL LAP STEEL SIDING 29 GA PVC OR ENTEX</p>	 <p>DOUBLE 4" TRADITIONAL LAP STEEL SIDING 29 GA PVC OR ENTEX</p>	 <p>DOUBLE 4" DUTCHLAP STEEL SIDING 29 GA PVC OR ENTEX</p>	 <p>12" VERTICAL (BOARD & BATTEN) STEEL SIDING 29 GA PVC, ENTEX OR PRISM</p>
 <p>3 1/4" SNAP-ON OUTSIDE CORNER POST CAP</p>	 <p>5/8" OR 1 1/8" SNAP-ON CORNER SUBSTRATE</p>	 <p>STARTER STRIP - STEEL</p>	 <p>5/8", 7/8", & 1 1/4" J-CHANNEL</p>	 <p>UNDERSILL TRIM</p>
 <p>SNAP-ON FRIEZE TRIM - STEEL</p>	 <p>Z-FLASHING (FOR VERTICAL SIDING)</p>	 <p>24" STEEL, 18" OR 24" ALUMINUM COIL STOCK</p>	 <p>CAULKING - SILICONE OR QUAD POLYMER GALVANIZED NAILS OR STAPLES</p>	 <p>UNDERLAYMENTS AND HOUSEWRAPS</p>

Tools & Equipment List

1. Cutting Tools
 - a. Power Saw with metal cutting blade (pg.5)
 - b. Guillotine cutter
 - c. Snips (Aviation or Duckbill)
 - d. Power Shear
 - e. Hack Saw with fine tooth blade
2. Portable Metal Bending Brake
3. Ladders and Ladder Jacks
4. Scaffolding
5. Planking
6. Hammer - 16 oz. Claw or Framing
7. Level - 24" minimum length
8. Chalkline or Dryline - 100'
9. Tape Measure - 25'
10. Caulking Gun
11. Scratch Awl
12. Sawhorses or Cutting Table
13. Framing Square
14. Crosscut Hand Saw
15. Protective wear
16. Hand Brake

THIS INSTALLATION MANUAL IS INTENDED TO BE A GUIDELINE FOR INSTALLING OUR STEEL-KORE STEEL SIDING PRODUCTS, BUT DUE TO SPACE LIMITATIONS WE ARE ONLY SHOWING THE MORE COMMON WAYS TO APPLY THE SIDING AND ACCESSORIES. THERE MAY BE MORE WAYS THAT ARE ACCEPTABLE THAT ARE NOT SHOWN HERE FOR INSTALLING THE STEEL SIDING AND ACCESSORIES. IF YOU HAVE ANY QUESTIONS PLEASE CALL BEST BUY METALS AT 800-728-4010. EDCO PRODUCTS ASSUMES NO RESPONSIBILITY FOR LEAKS OR DAMAGE DUE TO FAULTY APPLICATION. EDCO STEEL-KORE SIDING PRODUCTS ARE COVERED BY A LIFETIME LIMITED WARRANTY. FOR A COPY OF THE WARRANTY CALL 800-593-2580 OR BEST BUY METALS. USE A PROFESSIONAL CONTRACTOR FOR INSTALLATION OF YOUR STEEL-KORE STEEL SIDING.

SURFACE PREPARATION

How good the finished job looks depends on how well the applicator prepared the wall surface. The applicator should check for low spots, loose or rotted boards, and buildup of paint or caulking. If any of these problems are found they should be corrected before the siding and accessories are applied.

Downspouts, lights, shutters, and any other items that might interfere with the installation of the siding should be removed before starting any part of the installation. Special care should be taken to tie back bushes and flowers that might be damaged during installation of the siding. (FIG. A)

Window sill extensions can be trimmed flush with the sides of the windows so the J-Channel will fit flush against the window. (FIG. B)

If there are low spots in the plane of the wall, the applicator should build out the areas with shims, wood lath or wood furring strips. The furring strips can be used for both vertical and horizontal siding, but make sure that the strips run the opposite direction of the siding. Wood furring strips are normally 1" x 2" or 1" x 3" and should be applied 16" to 24" on center. (FIG. C)

Insulating sheathing can be applied to the wall between the wood furring strips, on top of the wood furring strips or underneath the wood furring strips. The insulating sheathing can be either the fanfold or sheet type. Fanfold sheathing can be applied over existing siding without the furring strips.

A housewrap, or water-resistive barrier, is required to be installed underneath the siding by many municipalities. The housewrap will help minimize water intrusion into the wall by moving the bulk of the water penetration and rain driven water away from the members of the wall system. In addition, to moving water away from the interior wall the housewrap should allow moisture to escape thus reducing the potential for moisture problems such as mold, mildew and rot. Check with the local building official to see what type of housewrap is required and remember to follow the manufacturer's directions when applying it to the wall. (FIG. D)

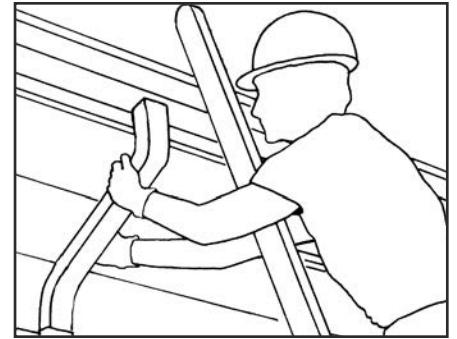

FIG. A

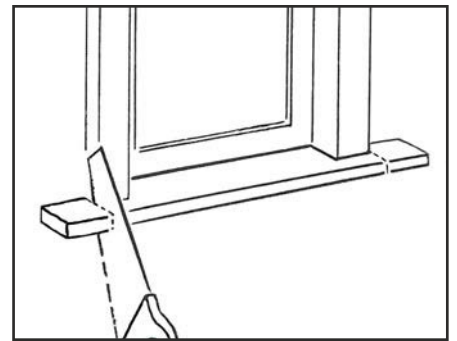

FIG. B

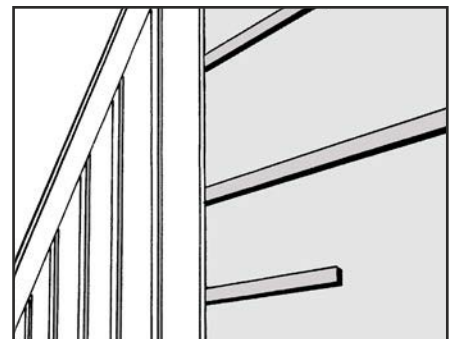

FIG. C

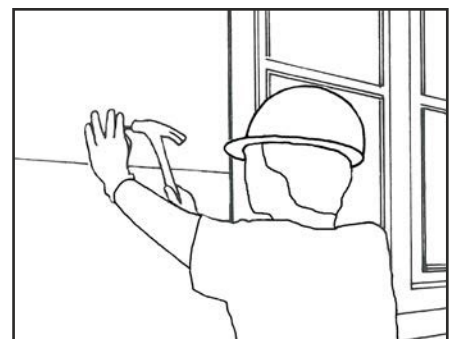

FIG. D

STARTER STRIP AND CORNERS

EDCO's two-piece corner system makes installing steel siding easier. The substrate is installed first and the snap-on corner cap is installed after the siding is installed. Make sure the base is fastened securely to the building and that the substrate is not twisted (see illustration). Hold the substrate $\frac{1}{4}$ " higher than the bottom of the starter strip. Nail the substrate every 12" on center with steel nails on both flanges. Make sure to use the correct size substrate for your job. (Installation of the snap-on corner cap is described later).

At the inside corners, two pieces of J-Channel will be installed face to back (see illustration). The J-Channels should be held $\frac{1}{4}$ " above the bottom of the starter strip. Nail the J-Channels every 16" on center. (An alternate installation would be to put a color matched flashing in the inside corner. After the flashing is in place, siding is applied to one wall and then a J-Channel is butted up against the siding.)

The starter strip is installed after the corner bases are installed. When applying the starter strip make sure that you have established a straight, level line to use as a reference for the starter strip. A common way to get this reference line is to take a measurement at all of the corners from the soffit down to the bottom of the siding. After you have all the measurements go to the lowest corner and set up your chalk line. Put the chalk line at the same level that you would like the top edge of the starter strip to be at.

Using the chalk line as your guide, nail the starter strip in place using a galvanized nail spaced every 12". The starter strip might need to be furred out to keep the siding sloped at the proper pitch (see illustration). The starter strip should overlap the corner substrate to help minimize air infiltration. The starter strip will go all the way around the base of the building. If a piece needs to be cut it should be cut with a tin snips. When installing starter pieces next to each other leave approximately $\frac{1}{8}$ " between the pieces for expansion and contraction. DO NOT overnail as this may make it tough to install the bottom course of siding.

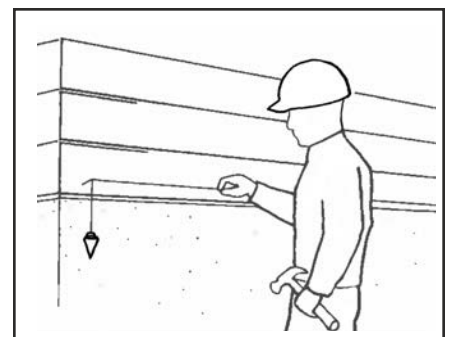
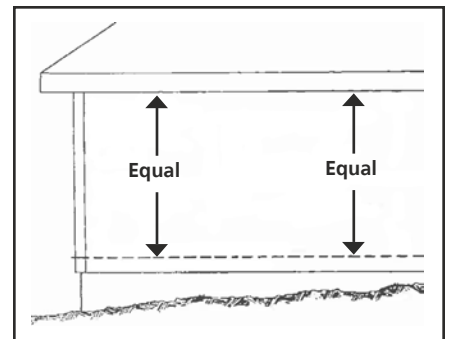
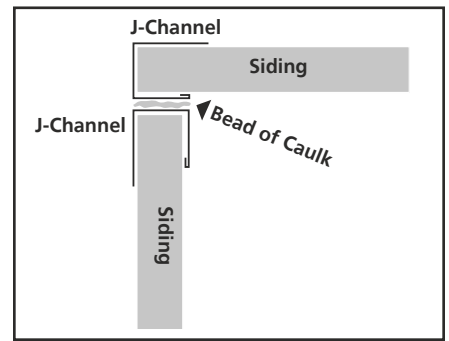
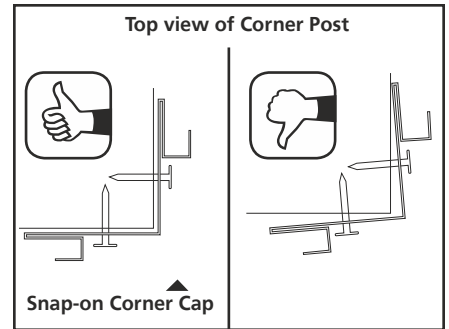

CUTTING PANELS

Panels may need to be cut to size to fit at the end of one course of siding. Panels will need to be cut so that the laps are staggered and above and below windows and doors. Write down the measurements of the panels that need to be cut and double-check before you cut the panel.

Power Saw

Typically, steel should not be cut using any heat-generating device such as an electric circular saw or jigsaw—to do so may destroy the protective galvanized coating and damage the siding. However, a power saw can be used on steel if using an approved Tenryu saw blade. Consult your representative.

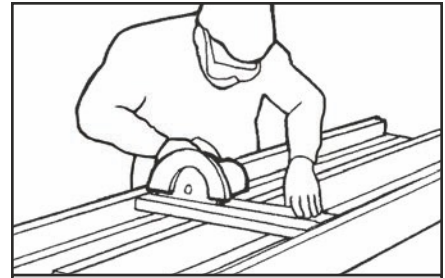

CAUTION: Safety glasses should be worn when operating a power saw.

Guillotine Cutter

A guillotine cutter will give you a clean, accurate cut without damaging the galvanized coating. A guillotine cutter will only make cuts that go across the panel. Make sure that you are using the proper guillotine cutter and that the blade is sharp.

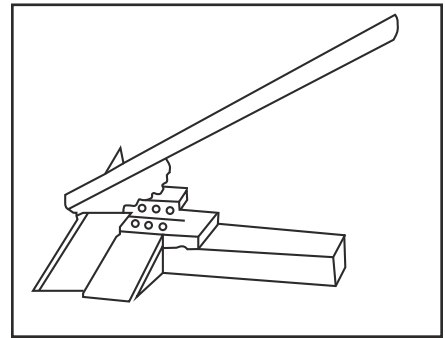

Tin Snips

Tin snips can be used to make any type of cut on a steel siding panel. They are a necessity when the job has gable ends.

Tin snips can be used to make a cutout for a door or a window. Draw the outline of the cutout on the siding panel. Proceed to make the cutout by starting at the top of the panel. If the locking lip gets flattened while it is being cut make sure that you use a screwdriver blade to open it.

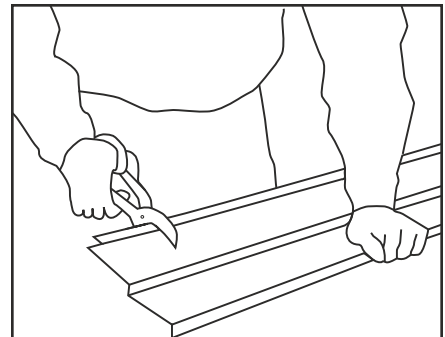

Electric Shears

Electric shears can be used to make long horizontal cuts. Electric shears will make a clean cut more quickly than a pair of tin snips. Electric shears can also be used on flat surface cuts of angle cuts.

TRIMMING WINDOWS AND DOORS

J-Channel is used around the windows and doors to receive the siding. J-Channel is a finished product and all exposed cuts and folds should be neat and clean. J-Channel is used at the bottom of the window and on the sides of the window.

The J-Channel for underneath the windows will be installed first and the J-Channel should be cut $1\frac{1}{4}$ " wider than the window sill. Notch the J-Channel $\frac{5}{8}$ " on both ends. The notched flaps will be folded up against the sides of the windows. Nail the channel 16" on center with a galvanized siding nail.

The side J-Channel is installed next and should be cut square at the top whether you are going to mitre cut or wrap the bottom of the window side J-Channel. If you are going to mitre cut the J-Channel, the side J-Channel should be cut $\frac{5}{8}$ " longer than the window side. If you are going to wrap the bottom of the J-Channel cut it $1\frac{1}{4}$ " longer than the window side.

After cutting the J-Channel for the side of the window notch the piece at the bottom so that the channel flap can be folded under the window sill. Cut the face at 45° if you are mitering the J-Channel. Nail the channel in place with galvanized nails spaced at 16" on center. Bend the face around the bottom J-Channel if you are wrapping the J-Channels together.

The top of the window should be flashed with a pre-made or custom bent Drip Cap. Cut the Drip Cap $1\frac{1}{2}$ " longer than the width of the window. Notch both ends of the drip cap in $\frac{3}{4}$ " for the flap that will be bent down into the J-Channel on the side of the windows.

NOTE: ASSURE THAT ALL PENETRATIONS THROUGH THE UNDERLAYMENT AND/OR HOUSEWRAP ARE PROPERLY SEALED IN ACCORDANCE WITH LOCAL BUILDING CODES.

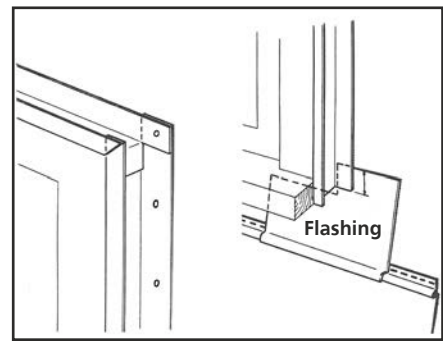
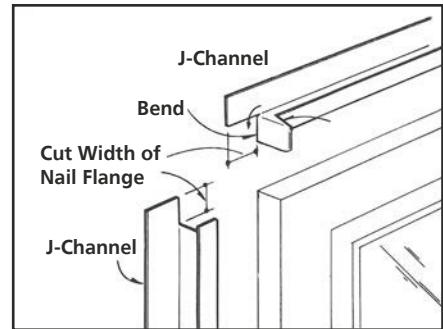

INSTALLING STEEL SIDING

First Course

Extra care should be taken when starting the first course of steel siding as this is the base for all other panels that will follow. Apply the first panel by hooking the bottom lock of the panel into the interlock bead of the starter strip. Make sure that the panel is properly hooked into the starter strip. Do not force the panel into place as this may distort the panel. Double-check to be sure that the panel is still locked properly before proceeding with the next panel.

Make sure that the bottom edge of the first panel is a minimum 6" above ground level at all points.

Using Foam Backer

If you are installing the siding with a foam drop-in backer the siding panel must be locked into the starter strip first and then the foam should be dropped in.

Lock the panel into place and tilt the top of the panel away from the building and then drop or insert the foam pieces.

Lapping

After the first panel has been properly fastened in place, the second and subsequent panels can be installed. When applying the siding make sure that the laps are not visible from the prominent view. On some walls you may have to lap the panels in more than one direction as there may be a door or deck that will be in the middle of the wall.

Make sure that the laps are laying flat. If they are not laying flat check the panel to see what is causing the problem. Factory cut laps should be lapped over top of field cut laps.

Overlapping

Panels should be lapped with no more than 1/2" between the nailing flanges. This will allow for expansion and contraction of the panels due to temperature changes.

Avoid using short pieces as they sometime get out of level and then the laps might not lay flat together.

Proper Staggering of Panels

Laps that are in a line vertically should be separated by two or more courses of siding. Separate laps from one course to the next by at least 16". Joints above and below windows or doors should be avoided.

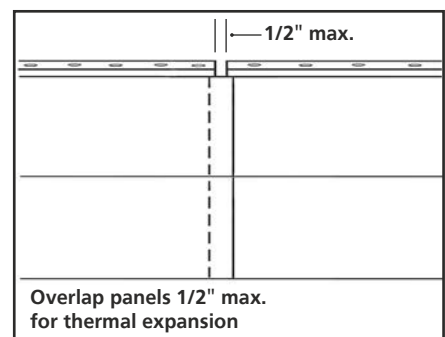
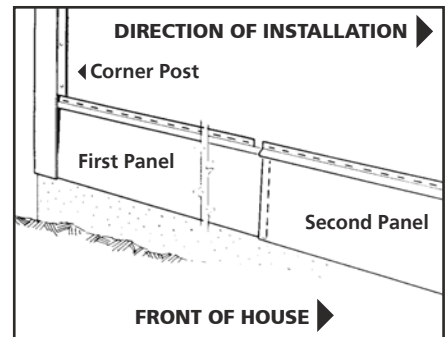
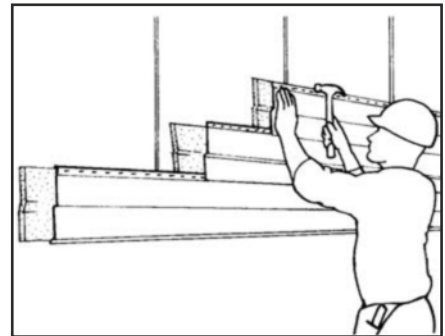
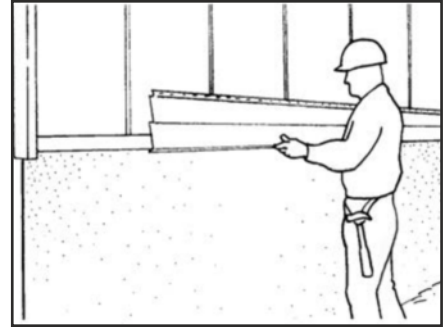

NAILING AND STAPLING

Hanging the Siding

When installing steel siding the panels are to be hung so that there is room for expansion and contraction of the panels. Not driving the fasteners tight also allows for the panels to "float" or smooth out any irregularities in the wall surface. Fasteners should be centered in the middle of the nailing slots and be driven straight in and not at an angle. Leaving a gap of no less than 1/32" between the head of the nail and the metal nailing flange will allow the panel to move freely.

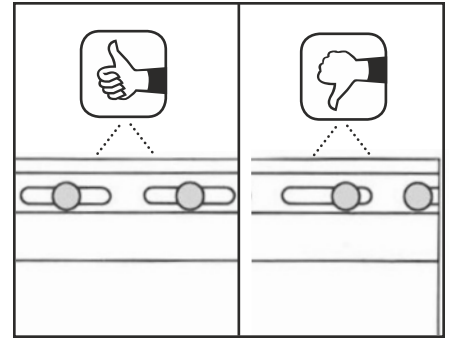

Fastening Rules

Fasteners should be spaced 16" on center and driven straight and level and not slanted up or down as this may distort the panel. Fasteners should not be driven closer than 5" from the end of the panel as this may distort the panel and cause the laps to be unsightly. Don't overdrive the fasteners.

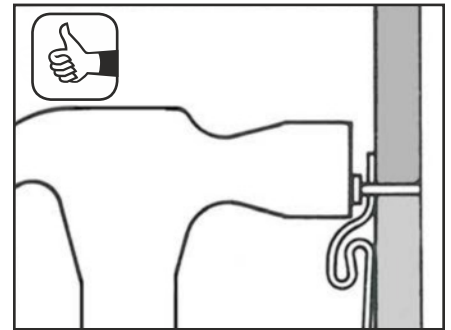

Nails

When nailing siding and accessories make sure to use the proper size nails. Use 2" galvanized nails (or longer) when installing siding with drop-in backer or over a fanfold type underlayment and 1 1/2" galvanized nails (or longer) for installations without insulation. Make sure that the nails are penetrating at least 3/4" into the stud for proper holding strength. If face-nailing is necessary be sure to use painted trim nails that match the siding color.

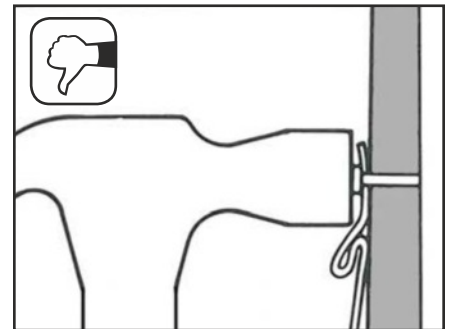

Pneumatic Staplers / Nailers

Powered fasteners are an acceptable method of installing steel siding. Follow the same procedures as you would if using nail such as driving the fasteners level and making sure that the fasteners are not overdriven. Make sure that the fasteners are corrosive resistant, such as cadmium-coated or galvanized steel. The leg of the fastener should be long enough to penetrate into the stud at least 3/4" and the width of the crown must be at least 3/8". Check the air pressure of the gun and adjust accordingly so that the fasteners are being driven to the correct depth.

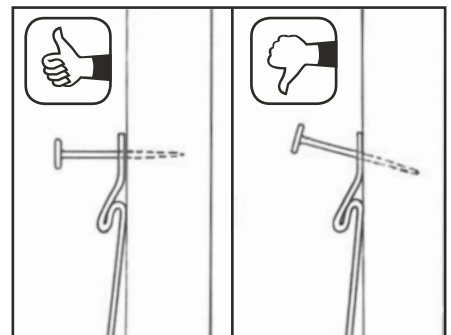

Remember to follow safety precautions when driving any fasteners whether they are power driven or driven by hand.

FINISHING ROW/GABLES & DORMERS

Finishing Touches

As you work your way up the wall towards the soffit area it is important to plan ahead for how the panels are going to lay out. You may need to install some furring strips along the horizontal soffit in order to achieve the proper slope with the last panel (see FIG A.) First, take a scrap piece of siding and cut it to the proper height to fit up against the soffit after the siding panel has been locked into the panel below. Slope your cut panel to match the panels below and then measure the distance between the wall and the top of the panel. This is the thickness of the furring strips that you will need to nail in place before installing the top row of siding. The cut edge of the panel should be covered with a piece of Undersill Trim.

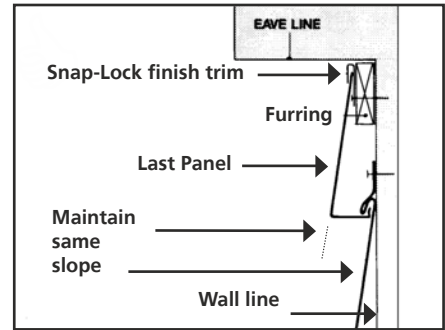
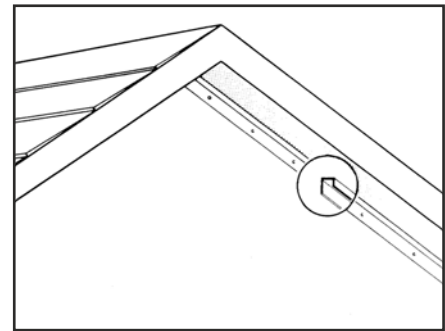

FIG. A

Gable Ends

Before applying siding in the gable end J-Channel should be applied to receive the siding panels. Start by running J-Channel up one side of the gable and cutting the J-Channel so it will butt into the soffit at the top. Next, run another J-Channel up the other side until it meets the first J-Channel and then trim the face for appearance.



Now, you can start installing the panels in the gable end. The ends of these panels will need to be cut at an angle to match the slope of the soffit. A good way to get the correct angle is to use two pieces of scrap siding as seen in the illustration to make a cutting template.

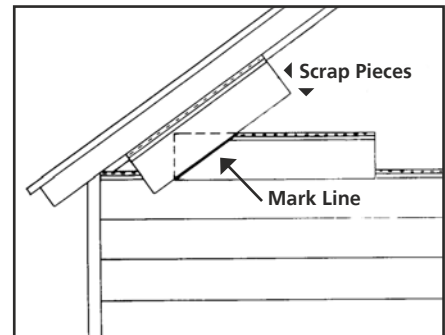

Slide the angled end of the cut panel into the J-Channel and lock into place. Nail and repeat the cutting and installation of panels. Extra care will need to be taken when you are cutting the panel on both ends for installation in the gable area. (Remember to allow for expansion and contraction.)

The last panel will need to be properly nailed in place with a colored nail

Snap-on Corner Cap

After all of the siding panels have been installed on the walls the Snap-on Corner Caps can be installed. Before installing the Snap-On Corner Cap, fold over a flap so that the bottom and top are closed off. The Snap-on Corner Caps can then be installed by hooking one of the edges onto the flange of the previously installed Snap-on Corner Substrate. Now, stretch the Snap-on Corner Cap and catch it on the other edge of the substrate. If the wall is taller than the length of the Snap-on Corner Cap notch the second post and lap over on the face of the lower corner cap. The Snap-on Corner Cap use a friction fit to stay in place and it may be necessary to put a small painted screw through the face of the corner cap and into the lip of the substrate. This should be done in a low visibility spot.

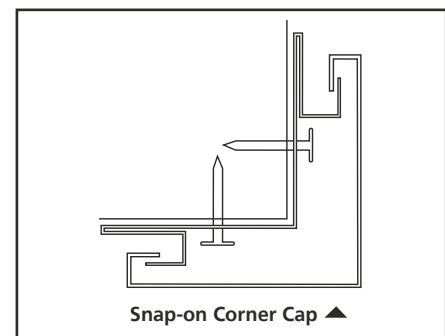

VERTICAL SIDING

Application

Vertical Siding can be used as an accent panel in gable ends or to do the whole exterior. Most procedures for installing Vertical Siding will be the same as outlined for horizontal siding. One exception is how the panels are started.

When starting to hang Vertical Siding you will need to install a piece of Z-Flashing horizontally along a line at the lowest point of the area that will have Vertical Siding installed. (FIG A.) The Z-Flashing will provide a straight edge for the Vertical Siding to sit up and it will also close off the open area of the battens on the siding.

After the Z-Flashing has been installed you can start installing the vertical panels. Depending on whether the area to be sided is a typical gable end or a wall will determine how and where you will nail the starter strip.

NOTE: YOU MAY NEED TO INSERT A WOOD LATH BEHIND THE PANEL TO MINIMIZE OILCANNING ON IRREGULAR SURFACES.

Gable Ends

If the vertical siding is going to be installed in the gable end of a home you normally would install the starter strip vertically in approximately the center of the gable (see illustration.) Next, take a panel and cut off the batten part of the panel. This piece will be cut to the correct length and slope. The cut edge will be inserted into the starter strip and nailed in place. After the cut panel has been secured in place, cut another panel to length and slope to hook into the other side of the starter strip. You can now proceed to side the rest of the wall by cutting and installing panels into both corners.

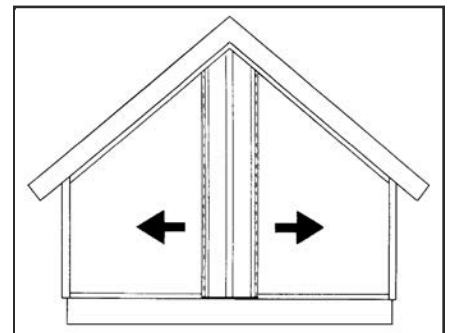
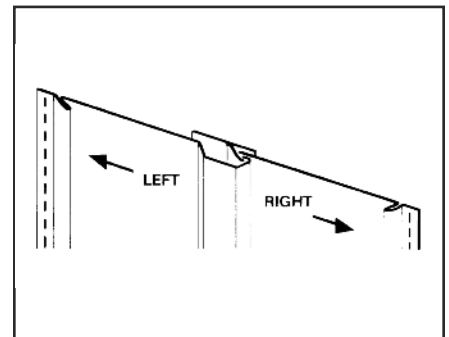
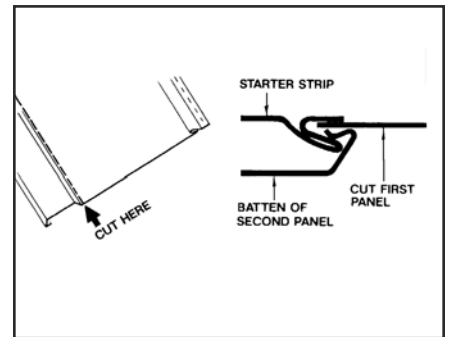
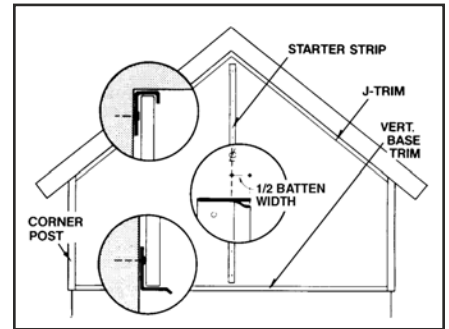

VERTICAL SIDING

Walls or between Windows

If you are installing Vertical Siding on wall areas you will need to install Z-Flashing as described above. After the Z-Flashing has been installed Outside Corners should be installed (See page 9.) Next, J-channel needs to be installed around the window and door openings. Cut the first panel to length and insert it onto the pocket of the outside corner post. Finish siding the wall with panels cut to fit.

When the panels butt into the side of a window or door they may need Undersill Trim to cover the cut edge of the panel. In some instances you may need to build out behind the panel as it goes into the J-Channel.

Walls over 10' High

If the wall that you are installing the vertical siding on is taller than 10'0" you can finish off the top edge of the lower panels with Z-Flashing. This will give you an excellent starting point for the panels to be installed above.

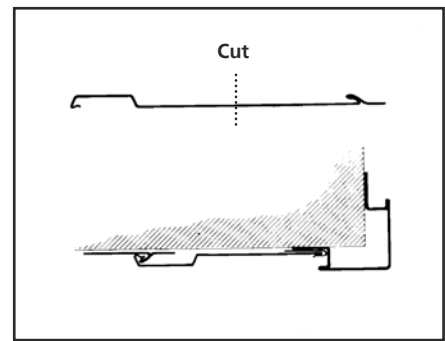
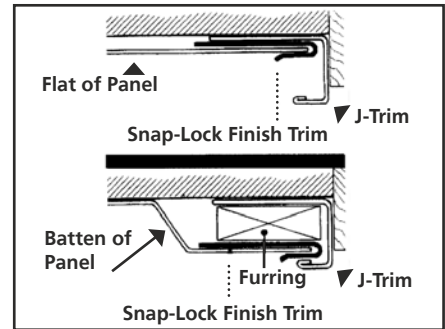



Metal Roofing & Siding, Nationwide

800-728-4010
bestbuymetals.com